

Return Grille & Filter

Includes throwaway filter, two duct bands, and clips.

Rough-in dimensions are shown.

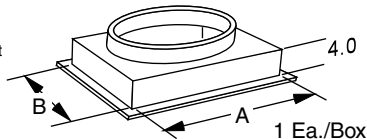

1 Ea./Box

P/N	Duct Dia.	Dimensions		Filter size
		A	B	
UPC-01-1218	12 (300)	20.25 (514)	14.25 (362)	14 x 20 (350 x 500)
UPC-01-2430	14 (350)	25.25 (631)	14.25 (362)	14 x 25 (350 x 625)
UPC-01-3036	16 (406)	30.25 (756)	14.25 (362)	14 x 30 (350 x 750)
UPC-01-3642	18 (450)	30.25 (756)	14.25 (362)	14 x 30 (350 x 750)
UPC-01-4860	20 (508)	30.25 (756)	24.25 (594)	24 x 30 (610 x 750)
UPC-01-4860NC	20 (508)	30.25 (756)	20.25 (514)	20 x 30 (500 x 750)

Air Filter

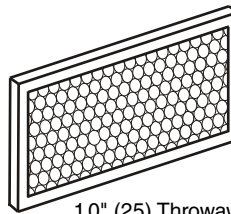

1.0" (25) Throwaway

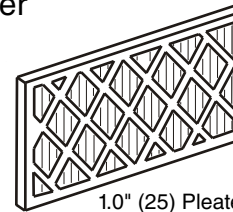

1.0" (25) Pleated

Size	Part No.	
	Throwaway	Pleated
12 x 16 (305 x 406)	A00097-011	-
14 x 20 (350 x 500)	A00097-007	-
14 x 25 (350 x 625)	A00097-005	-
14 x 30 (350 x 750)	A00097-006	-
14 x 38 (350 x 965)	A00097-008	-
18 x 20 (457 x 500)	-	A00558-003
18 x 25 (457 x 625)	-	A00558-004
18 x 18 (457 x 457)	-	A00558-005
20 x 30 (500 x 750)	A00097-009	-
24 x 30 (610 x 750)	A00097-010	-

Adapter, Return Air, Cooling Module

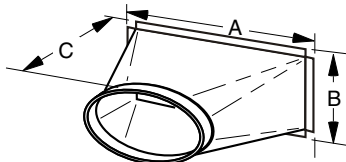

Includes insulation wrap shipped loose.

1 Ea./Box

P/N	Duct Dia.	Overall Dimensions	
		A x B x C	
UPC-59-2430	14 (350)	22 x 13.5 x 11.5	(559 x 338 x 288)
UPC-59-3036	16 (406)	27 x 13.5 x 11.5	(686 x 338 x 288)
UPC-59-3642	18 (450)	35 x 13.5 x 10.5	(875 x 338 x 263)
UPC-59-4860	20 (508)	35 x 11.5 x 15.0	(875 x 292 x 381)

Return Air Duct

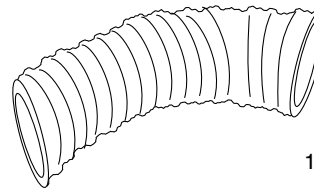

1 Ea./Box

- Tough Aluminized outer mylar wrap
- Spun-bonded nylon and helical wire core
- 1" (25 mm) Fiberglass insulation, R-4.2
- 10 ft (3050 mm) lengths

P/N	Used On	Dia.
UPC-04-1218	1218	12.0 (300)
UPC-04-2430	2430	14.0 (350)
UPC-04-3036	3036	16.0 (406)
UPC-04-3642	3642	18.0 (450)
UPC-04-4860	4860	20.0 (508)

Adapter, Return Air, Heating Module

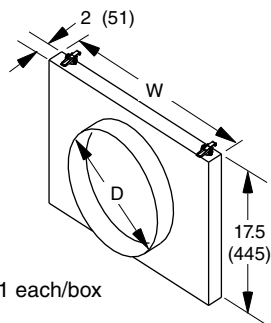

1 each/box

- Mates directly to Heating Module or Vertical Plenum Module
- No additional fabrication
- Can be used on either horizontal or vertical installations

Model	W	Duct Diameter
UPC-104-2430	25 (635)	14 (350)
UPC-104-3036	30 (762)	16 (406)
UPC-104-3642	38 (965)	18 (450)
UPC-104-4860	38 (965)	20 (508)

Adapter, Return Air, M1218

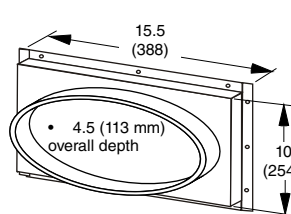

UPC-104-1218

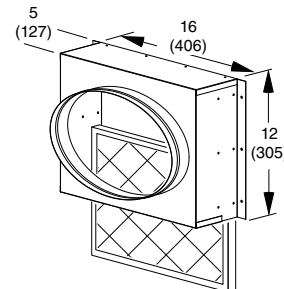

UPC-105-1218

- Mates directly to air handler
- No additional fabrication
- Can be used on either horizontal or vertical installations
- Duct collar for 12" (305) flexible duct
- UPC-105 includes 12 x 16 filter

1 each/box

Outlet Kits (1 Outlet)

Part No.	Duct		Plenum
	Dia	R-factor	
UPC-80F-1	2.0 (50)	R-3.2	Fiberglass ductboard, 1" (25)
UPC-80FR6-1	2.0 (50)	R-6.0	Fiberglass ductboard, 1.5" (38)
UPC-80M-1	2.0 (50)	R-3.2	Metal duct, round
UPC-80MR6-1	2.0 (50)	R-6.0	Metal duct, round
UPC-80MF-1	2.0 (50)	R-3.2	Metal duct, rectangular
UPC-280M-1	2.5 (63)	R-3.2	Metal duct, round
UPC-280MR6-1	2.5 (63)	R-6.0	Metal duct, round

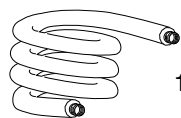

1 — 12 ft. (3660 mm) Sound Attenuator

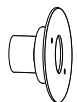

1 — Supply Outlet (White)



2 — Sound attenuator Clamps
2 — Supply Tubing Clamps



2 — Toggles and Screws



1 — Winter Supply Shutoff



1 — Coupling with Tape Rings



1 — Balancing Orifice Kit for one outlet
UPC-80 includes cap and two disks
UPC-280 is one piece

UPC-80F only



1 — Spin-In Take-off for Fiberglass ductboard

UPC-80M, UPC-280M only

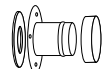

1 — Metal Take-off with gasket and tape ring

Installation Kits (Outlets, no duct)

Part No.	Outlet Qty	Duct Dia	Plenum
UPC-89F-8	8	2.0 (50)	Fiberglass ductboard, 1" (25)
UPC-80FR6-6	6	2.0 (50)	Fiberglass ductboard, 1.5" (38)
UPC-89M-6	6	2.0 (50)	Metal duct, round
UPC-89M-8	8	2.0 (50)	Metal duct, round
UPC-89MF-6	6	2.0 (50)	Metal duct, rectangular
UPC-89MF-8	8	2.0 (50)	Metal duct, rectangular
UPC-289M-5	5	2.5 (63)	Metal duct, round
UPC-289MF-5	5	2.5 (63)	Metal duct, rectangular

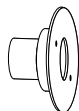

Qty — Supply Outlets (White)



Qty x 2 — Sound attenuator Clamps
Qty x 2 — Supply Tubing Clamps



Qty x 2 — Toggles and Screws



Qty — Winter Supply Shutoffs



Qty — Couplings with Tape Rings



1 — Balancing Orifice Kit for one outlet
UPC-80 includes cap and two disks
UPC-280 is one piece

UPC-89F only



Qty — Spin-In Take-off for Fiberglass ductboard

UPC-89M, UPC-280M only

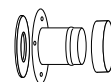

Qty — Metal Take-offs with gasket and tape ring

Outlet Kits, Short (5 Outlets)

- UPC-84-5 Outlet Kit for 1-inch Fiberglass Plenum
- UPC-85-5 Outlet Kit for Metal Plenum

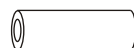

5 — 12" (300 mm) Rigid Attenuators

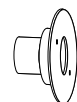

5 — Supply Outlets (White)



5 — Winter Supply Shutoffs



10 — Toggles and Screws

UPC-84-5 only



5 — Fiberglass Spin-In Take-offs

UPC-85-5 only

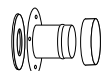

5 — Metal Take-offs with gasket and tape ring

Mounting Rails, M1218

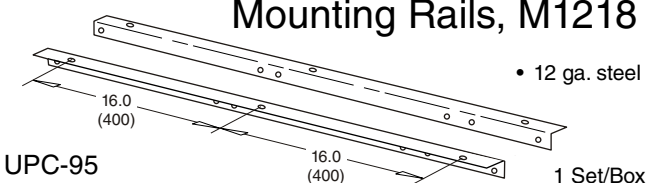





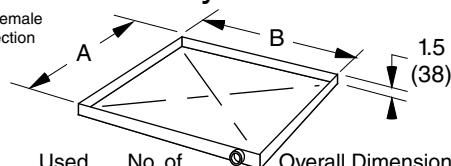

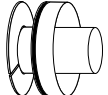
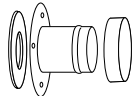
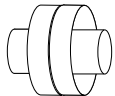

Secondary Drain Pan

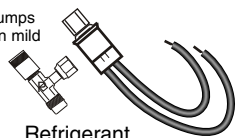

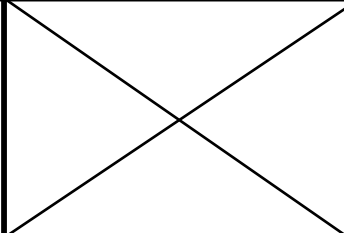
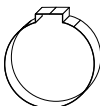
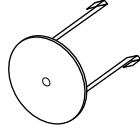
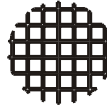

- 3/4-inch (19 mm) Female PVC Socket Connection

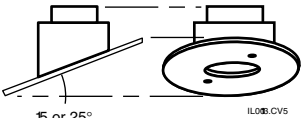
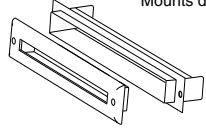
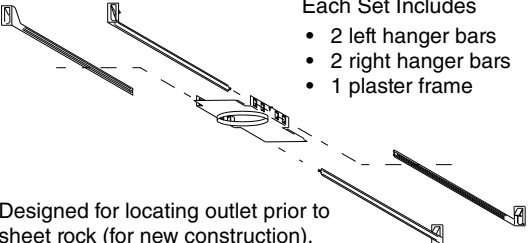
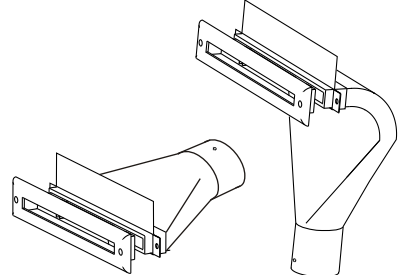

P/N	Used On	No. of Modules	Overall Dimensions A x B	
UPC-94	1218	-	24.0 x 42.0	(610 x 1067)
UPC-20B	2430	2	29.0 x 31.5	(737 x 800)
UPC-20C	2430	3	29.0 x 43.75	(737 x 1110)
UPC-27B	3036	2	34.0 x 31.5	(864 x 800)
UPC-27C	3036	3	34.0 x 43.75	(864 x 1110)
UPC-24B	3642	2	42.0 x 31.5	(1067 x 800)
UPC-24C	3642	3	42.0 x 43.75	(1067 x 1110)
"	4860	2	"	"
UPC-24D	4860	3	42.0 x 54.0	(1067 x 1372)

<h3>Spin-In Takeoff</h3>  <p>1 Ea./Box</p> <table border="1"> <thead> <tr> <th>Part No.</th> <th>Duct</th> <th>Plenum</th> </tr> </thead> <tbody> <tr> <td>UPC-22</td> <td>2.0" (50)</td> <td>Fbrgls, 1.5"</td> </tr> <tr> <td>UPC-23B</td> <td>2.0" (50)</td> <td>Fbrgls, 1"</td> </tr> </tbody> </table>	Part No.	Duct	Plenum	UPC-22	2.0" (50)	Fbrgls, 1.5"	UPC-23B	2.0" (50)	Fbrgls, 1"	<h3>Metal Takeoff Pkg</h3>  <p>Includes tape ring and gasket 1 Ea./Box</p> <table border="1"> <thead> <tr> <th>Part No.</th> <th>Duct</th> <th>Plenum</th> </tr> </thead> <tbody> <tr> <td>UPC-28</td> <td>2.0" (50)</td> <td>Metal, rnd</td> </tr> <tr> <td>UPC-28F</td> <td>2.0" (50)</td> <td>Metal, flat</td> </tr> <tr> <td>UPC-228</td> <td>2.5" (63)</td> <td>Metal, rnd</td> </tr> <tr> <td>UPC-228F</td> <td>2.5" (63)</td> <td>Metal, flat</td> </tr> </tbody> </table>	Part No.	Duct	Plenum	UPC-28	2.0" (50)	Metal, rnd	UPC-28F	2.0" (50)	Metal, flat	UPC-228	2.5" (63)	Metal, rnd	UPC-228F	2.5" (63)	Metal, flat	<h3>Supply Duct Coupling</h3>  <p>Includes supply clamps and tape rings 10 Ea./Box</p> <table border="1"> <thead> <tr> <th>Part No.</th> <th>Duct</th> </tr> </thead> <tbody> <tr> <td>UPC-38C-10</td> <td>2.0" (50)</td> </tr> <tr> <td>UPC-238C-10</td> <td>2.5" (63)</td> </tr> </tbody> </table>	Part No.	Duct	UPC-38C-10	2.0" (50)	UPC-238C-10	2.5" (63)	<h3>Winter Shutoff (2")</h3>  <p>20 Ea./Box</p> <table border="1"> <thead> <tr> <th>Part No.</th> <th>Duct</th> </tr> </thead> <tbody> <tr> <td>UPC-42-20</td> <td>2.0" (50)</td> </tr> <tr> <td>UPC-242-20</td> <td>2.5" (63)</td> </tr> </tbody> </table>	Part No.	Duct	UPC-42-20	2.0" (50)	UPC-242-20	2.5" (63)				
Part No.	Duct	Plenum																																									
UPC-22	2.0" (50)	Fbrgls, 1.5"																																									
UPC-23B	2.0" (50)	Fbrgls, 1"																																									
Part No.	Duct	Plenum																																									
UPC-28	2.0" (50)	Metal, rnd																																									
UPC-28F	2.0" (50)	Metal, flat																																									
UPC-228	2.5" (63)	Metal, rnd																																									
UPC-228F	2.5" (63)	Metal, flat																																									
Part No.	Duct																																										
UPC-38C-10	2.0" (50)																																										
UPC-238C-10	2.5" (63)																																										
Part No.	Duct																																										
UPC-42-20	2.0" (50)																																										
UPC-242-20	2.5" (63)																																										
<h3>Mild Weather Kit</h3> <p>For heat pumps operating in mild weather.</p>  <table border="1"> <thead> <tr> <th>Part No.</th> <th>Refrigerant</th> </tr> </thead> <tbody> <tr> <td>UPC-65</td> <td>R-22/407C</td> </tr> <tr> <td>UPC-65X</td> <td>R-410A</td> </tr> </tbody> </table> <p>1 Ea./Box</p>	Part No.	Refrigerant	UPC-65	R-22/407C	UPC-65X	R-410A	<h3>Outlet Hardware Pkg</h3>  <p>Each set includes 1 - Toggle 1 - Screw, #4-24 x 1.5</p> <p>UPC-51 12 sets/Pkg</p>	<h3>Clamp Pliers</h3>  <p>UPC-54 1 Ea./Box</p>																																			
Part No.	Refrigerant																																										
UPC-65	R-22/407C																																										
UPC-65X	R-410A																																										
<h3>Tubing Clamp</h3>  <p>50 Ea./Box</p> <table border="1"> <thead> <tr> <th>Part No.</th> <th>Duct Dia</th> <th>Type</th> </tr> </thead> <tbody> <tr> <td>UPC-52-50</td> <td>2.0" (50)</td> <td>AL Supply</td> </tr> <tr> <td>UPC-53-50</td> <td>2.0" (50)</td> <td>Attenuator</td> </tr> <tr> <td>UPC-252-50</td> <td>2.5" (63)</td> <td>AL Supply</td> </tr> <tr> <td>UPC-253-50</td> <td>2.5" (63)</td> <td>Attenuator</td> </tr> </tbody> </table>	Part No.	Duct Dia	Type	UPC-52-50	2.0" (50)	AL Supply	UPC-53-50	2.0" (50)	Attenuator	UPC-252-50	2.5" (63)	AL Supply	UPC-253-50	2.5" (63)	Attenuator	<h3>Outlet Deflector</h3>  <p>5 Ea./Box</p> <table border="1"> <thead> <tr> <th>Part No.</th> <th>Duct</th> </tr> </thead> <tbody> <tr> <td>UPC-45-5</td> <td>2.0" (50)</td> </tr> <tr> <td>UPC-245-5</td> <td>2.5" (63)</td> </tr> </tbody> </table>	Part No.	Duct	UPC-45-5	2.0" (50)	UPC-245-5	2.5" (63)	<h3>Outlet Screen</h3>  <p>20 Ea./Box</p> <table border="1"> <thead> <tr> <th>Part No.</th> <th>Duct</th> <th>Color</th> </tr> </thead> <tbody> <tr> <td>UPC-88-20</td> <td>2.0" (50)</td> <td>WHITE</td> </tr> <tr> <td>UPC-88-20-BLK</td> <td>2.0" (50)</td> <td>BLACK</td> </tr> <tr> <td>UPC-288-20</td> <td>2.5" (63)</td> <td>WHITE</td> </tr> <tr> <td>UPC-288-20-BLK</td> <td>2.5" (63)</td> <td>BLACK</td> </tr> </tbody> </table>	Part No.	Duct	Color	UPC-88-20	2.0" (50)	WHITE	UPC-88-20-BLK	2.0" (50)	BLACK	UPC-288-20	2.5" (63)	WHITE	UPC-288-20-BLK	2.5" (63)	BLACK	<h3>Fiberglass Ductboard Hole Cutter</h3>  <p>5 Ea./Box</p> <table border="1"> <thead> <tr> <th>Part No.</th> <th>Duct</th> </tr> </thead> <tbody> <tr> <td>UPC-55-5</td> <td>2.0" (50)</td> </tr> </tbody> </table>	Part No.	Duct	UPC-55-5	2.0" (50)
Part No.	Duct Dia	Type																																									
UPC-52-50	2.0" (50)	AL Supply																																									
UPC-53-50	2.0" (50)	Attenuator																																									
UPC-252-50	2.5" (63)	AL Supply																																									
UPC-253-50	2.5" (63)	Attenuator																																									
Part No.	Duct																																										
UPC-45-5	2.0" (50)																																										
UPC-245-5	2.5" (63)																																										
Part No.	Duct	Color																																									
UPC-88-20	2.0" (50)	WHITE																																									
UPC-88-20-BLK	2.0" (50)	BLACK																																									
UPC-288-20	2.5" (63)	WHITE																																									
UPC-288-20-BLK	2.5" (63)	BLACK																																									
Part No.	Duct																																										
UPC-55-5	2.0" (50)																																										
<h3>Round Outlet, Plastic (Air Register)</h3>  <p>Includes: toggles, screws, attenuator clamp, ceiling gasket Standard: White 1 Ea./Box</p> <table border="1"> <thead> <tr> <th>Part No.</th> <th>Duct Dia</th> </tr> </thead> <tbody> <tr> <td>UPC-56B</td> <td>2.0" (50)</td> </tr> <tr> <td>UPC-256</td> <td>2.5" (63)</td> </tr> </tbody> </table> <p>Optional finishes -BLK (Black) -BRS (Brass) -CHR (Chrome)</p>	Part No.	Duct Dia	UPC-56B	2.0" (50)	UPC-256	2.5" (63)	<h3>Round Outlet, Wood (Air Register)</h3>  <p>Standard: Red Oak (unfinished) Includes: outlet screen, attenuator clamp 1 Ea./Box</p> <table border="1"> <thead> <tr> <th>Part No.</th> <th>Duct Dia</th> </tr> </thead> <tbody> <tr> <td>UPC-57</td> <td>2.0" (50)</td> </tr> <tr> <td>UPC-257</td> <td>2.5" (63)</td> </tr> </tbody> </table> <p>Wood species available -B (Birch) -PI (Pine) -C (Cherry) -PO (Poplar) -K (Knotty Pine) -RO (Red Oak) -MA (Maple) -WL (Walnut) -MH (Mahogany) -WO (White Oak)</p>	Part No.	Duct Dia	UPC-57	2.0" (50)	UPC-257	2.5" (63)	<h3>Round Outlet, Sloped Ceiling, Plastic</h3>  <p>Includes: toggles, screws, attenuator clamp, ceiling gasket Standard: White 1 Ea. \ Box</p> <table border="1"> <thead> <tr> <th>Part No.</th> <th>Duct Dia</th> <th>Angle</th> </tr> </thead> <tbody> <tr> <td>UPC-58-1-15</td> <td>2.0" (50)</td> <td>15°</td> </tr> <tr> <td>UPC-58-1-25</td> <td>2.0" (50)</td> <td>25°</td> </tr> </tbody> </table>	Part No.	Duct Dia	Angle	UPC-58-1-15	2.0" (50)	15°	UPC-58-1-25	2.0" (50)	25°	<h3>Plenum Outlet</h3>  <p>Mounts directly to plenum 1 Ea. \ Box</p> <p>Includes: mounting bracket, screws, trim plate (white is standard)</p> <p>UPC-101</p> <p>Optional finishes -BLK (Black) -BRS (Brass) -CHR (Chrome)</p>																			
Part No.	Duct Dia																																										
UPC-56B	2.0" (50)																																										
UPC-256	2.5" (63)																																										
Part No.	Duct Dia																																										
UPC-57	2.0" (50)																																										
UPC-257	2.5" (63)																																										
Part No.	Duct Dia	Angle																																									
UPC-58-1-15	2.0" (50)	15°																																									
UPC-58-1-25	2.0" (50)	25°																																									
<h3>Plaster Frame Kit</h3>  <p>Each Set Includes</p> <ul style="list-style-type: none"> • 2 left hanger bars • 2 right hanger bars • 1 plaster frame <p>Designed for locating outlet prior to sheet rock (for new construction).</p> <table border="1"> <thead> <tr> <th>Part No.</th> <th>Duct Size</th> </tr> </thead> <tbody> <tr> <td>UPC-86-5</td> <td>2.0" (50)</td> </tr> <tr> <td>UPC-286-5</td> <td>2.5" (63)</td> </tr> </tbody> </table> <p>5 Sets/Box</p>		Part No.	Duct Size	UPC-86-5	2.0" (50)	UPC-286-5	2.5" (63)	<h3>Slotted Outlet</h3>  <p>UPC-66 (Metal) UPC-67A (Plastic) UPC-68 (Plastic)</p> <ul style="list-style-type: none"> • factory insulated • fits in standard 2 x 4 construction • includes mounting bracket with hanger bars • includes a white plastic trim plate, also available in metallic silver, brass, or unfinished wood. <p>UPC-68 UPC-66/67A</p> <p>1 Ea. \ Box</p>																																			
Part No.	Duct Size																																										
UPC-86-5	2.0" (50)																																										
UPC-286-5	2.5" (63)																																										

Outlet Balancing Orifice Package

-  15% Reduction (1-7/16" (36mm) hole) — 5 / Pkg
-  35% Reduction (1-1/8" (28 mm) hole) — 5 / Pkg
-  50% Reduction (15/16" (23 mm)hole) — 5 / Pkg
-  Winter Shutoff, 2-1/8" (53 mm) — 15 / Pkg

UPC-36-15

Supply Tubing

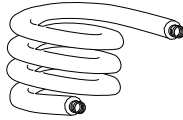

- Tough Aluminized mylar outer wrap
- Two-ply aluminum core
- Fully insulated,
- 25 ft (7625 mm) lengths
- Certified as an Air Duct per UL181

2" (50 mm) ID

Part No.	Ea/ Box	OD, in. (mm)	R-Factor
UPC-25-1	1	3.5 (89)	R-3.2 (R-4.2**)
UPC-25-4	4	3.5 (89)	R-3.2 (R-4.2**)
UPC-25-R4-4	4	4.0 (102)	R-4.2 (R-5.8**)
UPC-25-R6-4	4	5.0 (127)	R-6.0 (R-9.2**)
UPC-25-R8-4	4	6.1 (152)	R-8.0 (R-13.2**)

2.5" (63 mm) ID

Part No.	Ea/ Box	OD, in. (mm)	R-Factor
UPC-225-1	1	4.0 (102)	R-3.2 (R-4.2**)
UPC-225-3	3	4.0 (102)	R-3.2 (R-4.2**)
UPC-225-R4-3	3	4.5 (114)	R-4.2 (R-5.8**)
UPC-225-R6-4	3	5.5 (140)	R-6.0 (R-9.2**)
UPC-225-R8-3	3	6.7 (170)	R-8.0 (R-13.2**)

** equivalent insulation factor. Rated R-factor is based on flat wall insulation

Sound Attenuator

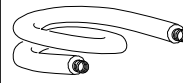

- Tough Aluminized mylar outer wrap
- Spun-bonded nylon and helical wire core
- Fully insulated
- 12 ft (7625 mm) lengths
- Certified as an Air Duct per UL181

2" (50 mm) ID

Part No.	Ea/ Box	OD, in. (mm)	R-Factor
UPC-26C-6	6	3.5 (89)	R-3.2 (R-4.2**)
UPC-26CR4-6	6	4.0 (102)	R-4.2 (R-5.8**)
UPC-26CR6-6	6	5.0 (127)	R-6.0 (R-9.2**)
UPC-26CR8-6	6	6.1 (152)	R-8.0 (R-13.2**)

2.5" (63 mm) ID

Part No.	Ea/ Box	OD, in. (mm)	R-Factor
UPC-226C-6	6	4.0 (102)	R-3.2 (R-4.2**)
UPC-226CR4-6	6	4.5 (114)	R-4.2 (R-5.8**)
UPC-226CR6-6	6	5.5 (120)	R-6.0 (R-9.2**)
UPC-226CR8-6	6	6.7 (170)	R-8.0 (R-13.2**)

** equivalent insulation factor. Rated R-factor is based on flat wall insulation

Takeoff Balancing Orifice Package, 2" Outlet

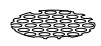
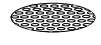
-  UPC-30 15% Reduction (Cap) — 15 / Pkg
-  UPC-31 35% Reduction (Perf. disk) — 5 / Pkg
-  UPC-32 50% Reduction (Perf. disk) — 5 / Pkg

UPC-35-15

Takeoff Balancing Orifice Package, 2.5" Outlet



5 Ea./Box

UPC-235-5

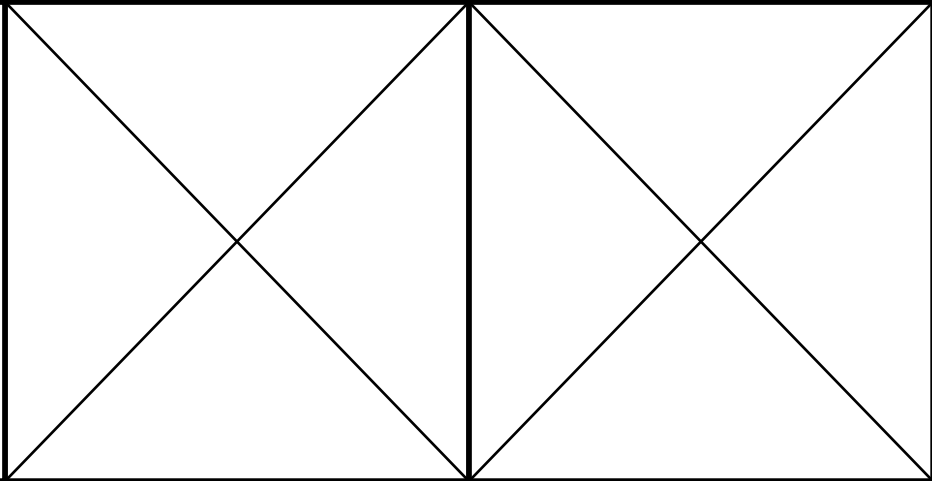

Square Fiberglass Ductboard Plenum and Fittings

Fiberglass Straight Duct

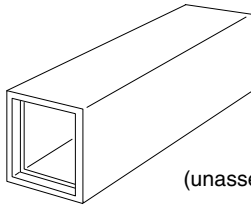

6 ft. (1829)
lengths

4 Ea./Box
(unassembled) 8 Ea./Box

R-4.2, wall thickness = 1.0 (25)

Part No. Square ID dimension

UPC-12-065S6-4 6.5 (163)

UPC-12-085S6-4 8.5 (216)

UPC-12-095S6-4 9.5 (241)

Unassembled (ships flat)

UPC-12-065S6-8F 6.5 (163)

UPC-12-085S6-8F 8.5 (216)

UPC-12-095S6-8F 9.5 (241)

R-6.0, wall thickness = 1.5 (38)

Part No. Square ID dimension

UPC-12-065R6-4 6.5 (163)

UPC-12-085R6-4 8.5 (216)

UPC-12-095R6-4 9.5 (241)

Unassembled (ships flat)

UPC-12-065R6-8F 6.5 (163)

UPC-12-085R6-8F 8.5 (216)

UPC-12-095R6-8F 9.5 (241)

Full Flow Fiberglass Tee

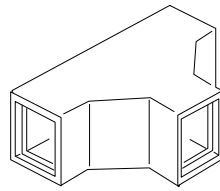

Includes
Splitter Vane

R-4.2, wall thickness = 1.0 (25)

Part No. Square ID dimension

UPC-16V-065S-X 6.5 (163)

UPC-16V-085S-X 8.5 (216)

UPC-16V-095S-X 9.5 (241)

X-designates no. in box, either 1 or 4

4 each/box

R-6.0, wall thickness = 1.5 (38)

Part No. Square ID dimension

UPC-16V-065R6-4 6.5 (163)

UPC-16V-085R6-4 8.5 (216)

UPC-16V-095R9-4 9.5 (241)

90° Fiberglass Elbow

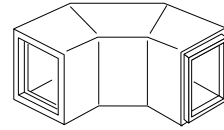

R-4.2, wall thickness = 1.0 (25)

Part No. Square ID dimension

UPC-18-065S-X 6.5 (163)

UPC-18-085S-X 8.5 (216)

UPC-18-095S-X 9.5 (241)

X-designates no. in box, either 1 or 4

4 each/box

R-6.0, wall thickness = 1.5 (38)

Part No. Square ID dimension

UPC-18-065R6-4 6.5 (163)

UPC-18-085R6-4 8.5 (216)

UPC-18-095R6-4 9.5 (241)

Fiberglass Reducer

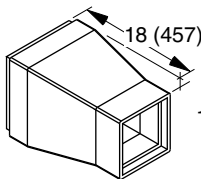

1 Ea./Box

R-4.2, wall thickness = 1.0 (25)

Model Square ID dimension

UPC-29-8565S-1 8.5 x 6.5 (216 x 163)

UPC-29-9565S-1 9.5 x 6.5 (241 x 163)

UPC-29-9585S-1 9.5 x 8.5 (241 x 216)

R-6.0, wall thickness = 1.5 (38)

Model Square ID dimension

UPC-29-8565R6-1 8.5 x 6.5 (216 x 163)

UPC-29-9565R6-1 9.5 x 6.5 (241 x 163)

UPC-29-9585R6-1 9.5 x 8.5 (241 x 216)

Fiberglass End Cap

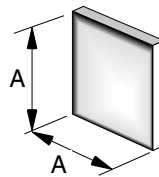

4 Ea./Box

R-4.2, wall thickness = 1.0 (25)

Model A

UPC-15-065S-4 7.5 (191)

UPC-15-085S-4 9.5 (241)

UPC-15-095S-4 10.5 (267)

R-6.0, wall thickness = 1.5 (38)

Model A

UPC-15-065R6-4 8.0 (203)

UPC-15-085R6-4 10.0 (254)

UPC-15-095R6-4 11.0 (280)

Fiberglass Duct
Splitter Vane

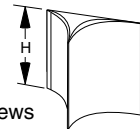

4 Ea./Box

Includes screws
and washers.

Model H

UPC-11-065S-4 6.38 (162)

UPC-11-085S-4 8.38 (213)

UPC-11-095S-4 9.38 (238)

Supply Air Plenum Adapter, Square

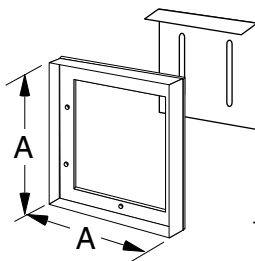

1 Ea./Box

- Includes:
- restrictor plate
 - insulation tape
 - mounting screws

P/N	Used On	Dimensions A	Square Duct size, ID
For R-4.2 Fiberglass Ductboard, wall thickness = 1.0 (25)			
UPC-62-1218*	1218	8.5 (216)	6.5 (165)
UPC-62-2430	2430	8.5 (216)	6.5 (165)
UPC-62-3036	3036	10.5 (267)	8.5 (178)
UPC-62-3642	3642	10.5 (267)	8.5 (178)
UPC-62-4860	4860	11.5 (292)	9.5 (241)
For R-6.0 Fiberglass Ductboard, wall thickness = 1.5 (38)			
UPC-62R6-1218*	1218	9.5 (241)	6.5 (165)
UPC-62R6-2430	2430	9.5 (241)	6.5 (165)
UPC-62R6-3036	3036	11.5 (292)	8.5 (178)
UPC-62R6-3642	3642	11.5 (292)	8.5 (178)
UPC-62R6-4860	4860	12.5 (318)	9.5 (241)

* 1218 Does not include restrictor plate

Round Metal Plenum Fittings

Duct, Metal

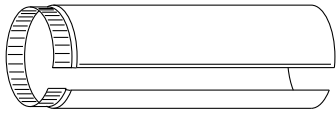

no insulation included

- 28 ga.
- one end crimped
- 5 ft. lengths

10 Ea./Box

Part No.	Duct Dia.
USM-01	7.0" (178)
USM-02	9.0" (228)
USM-13	10.0" (254)

End Cap

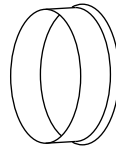

no insulation included

- 28 ga.
- no crimped end

12 Ea./Box

Part No.	Duct Dia.
USM-05	7.0" (178)
USM-06	9.0" (228)
USM-18	10.0" (254)

Elbow, 90°

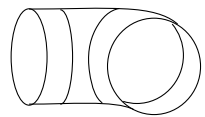

- 28 ga.
- no crimped ends

no insulation included

12 Ea./Box

Part No.	Duct Dia.
USM-03	7.0" (178)
USM-04	9.0" (228)
USM-14	10.0" (254)

Tee

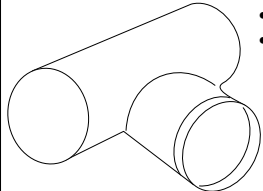

- 28 ga.
- no crimped ends

no insulation included

4 Ea./Box

Part No.	Duct Dia.
USM-07	7.0" (178)
USM-08	9.0" (228)
USM-15	10.0" (254)

Reducer Tee

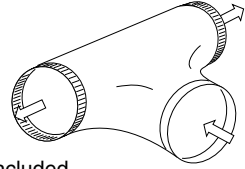

- 28 ga.
- no crimped ends

no insulation included

4 Ea./Box

Part No.	Duct Dia.
USM-09	9x7x7 (225x175x175)
USM-19	10x9x9 (254x225x225)

Reducer Tee

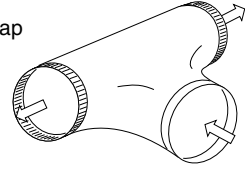

Includes:

- insulation wrap
- splitter vane

1 Ea./Box

UPC-19V-090707
9 x 7 x 7 (225 x 175 x 175)

UPC-19V-100909
10 x 9 x 9 (254 x 225 x 225)

Reducer

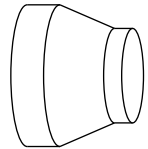

- 28 ga.
- no crimped ends

no insulation included

4 Ea./Box

Part No.	Duct Dia.
USM-12	9 x 7 (254 x 178)
USM-17	10 x 9 (254 x 228)

Insulation Sleeve

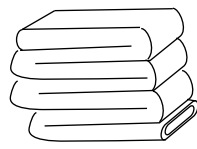

- 2" thick (R-8)
- 5 ft. lengths

12 Ea./Box

Part No.	Duct Dia.
USM-10	7.0" (178)
USM-11	9.0" (228)
USM-16	10.0" (254)

Splitter Vane

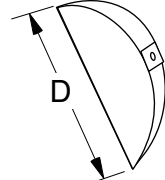

Includes screws and washers.

4 Ea./Box

Model	D
UPC-11-07R-4	7.0 (178)
UPC-11-09R-4	9.0 (229)
UPC-11-10R-4	10.0 (254)

Supply Air Plenum Adapter, Round

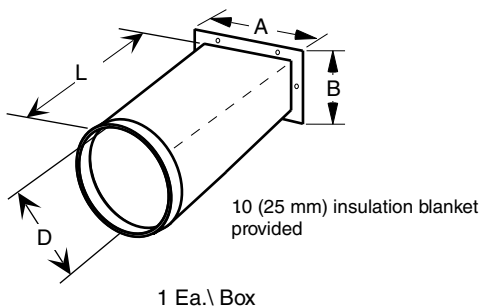

P/N	Used On	Overall Dimensions			Dia. D
		A	B	L	
UPC-61-1218	1218	8.0 (203)	4.75 (121)	12.0 (305)	7.0 (178)
UPC-61-2430	2430	7.5 (191)	8.0 (203)	12.0 (305)	7.0 (178)
UPC-61-3036	3036	8.68 (220)	8.0 (203)	18.0 (457)	9.0 (229)
UPC-61-3642	3642	8.68 (220)	8.0 (203)	18.0 (457)	9.0 (229)
UPC-61-4860	4860	11.63 (295)	8.0 (203)	18.0 (457)	10.0 (254)