

Webstone

VALVE INNOVATION

PRODUCT CATALOG

**QUALITY AND COMMITMENT
TO TECHNOLOGY AND SERVICE SINCE 1954**

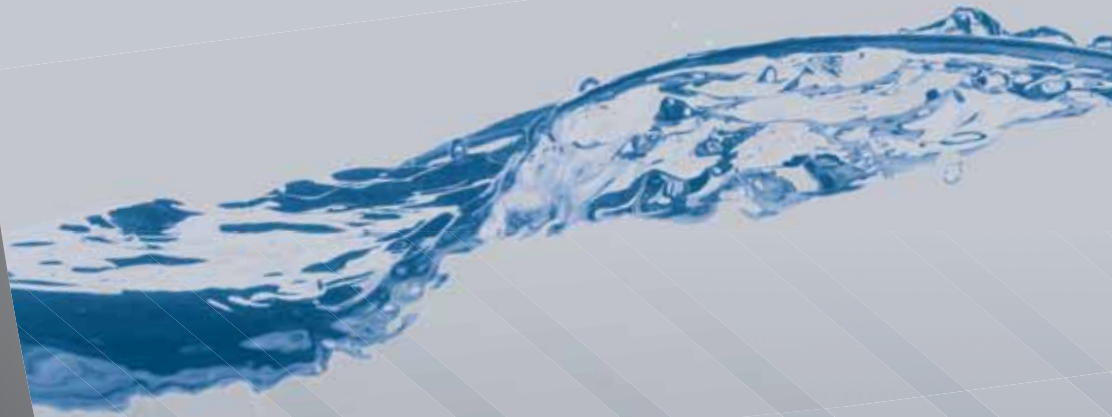

The ISOLATOR
UNI-FLANGE BALL VALVE®

PRO-PAL
SERIES

The ISOLATOR®
E·X·P
TWH SERVICE VALVES

HYDRO-CORE
™

PRO-CONNECT
VALVES + FITTINGS

THE WEB WARRANTY • PRODUCTS BUILT TO LAST A LIFETIME

Webstone Company, Inc. warrants all of its products to be free from manufacturer defects in material and/or workmanship for the life of the product, provided they are professionally installed and operated under normal conditions. Webstone will replace, FREE OF CHARGE, any product or part thereof that proves defective in material and/or workmanship under normal installation, use, and service.

FOR FULL DETAILS CONTACT WEBSTONE COMPANY, INC. (800) 225-9529

WEB TRACK SYSTEM SAME DAY SHIPPING AND MORE

All orders placed with Webstone are now processed by our automated Web Track System. Upon receipt of your order, the Web Track System processes it for shipment THE SAME DAY (if received by 1:00 PM EST). Upon shipment, Web Track information is transmitted to you via your preference of fax or email. It serves as your invoice and shipping confirmation. This confirmation invoice includes the carrier name, pro or tracking number, quantities shipped, quantities backordered (if any), and your costs. That means:

**NO MORE LONG LEAD TIMES
FOR ORDER SHIPMENT**

**NO MORE CALLING TO CHECK
ON YOUR ORDER STATUS**

**NO MORE WONDERING IF IT
WILL SHIP COMPLETE OR PARTIAL**

And it doesn't stop there, through our website
WWW.WEBSTONEVALVES.COM
you can do MUCH MORE!

PLACE NEW ORDERS

FIND PART NUMBERS

PRINT SPECIFICATION/SUBMITTAL SHEETS

TRACK YOUR SHIPMENT

UPDATE ACCOUNT INFORMATION

PRINT INVOICES

DOWNLOAD CURRENT BROCHURES & CATALOGS

**AND CONTACT US FOR ANY SPECIAL
ASSISTANCE YOU MAY NEED!**

TERMS OF SERVICE

TERMS OF PAYMENT 2% 10th of the following month. Cash discount is calculated on the total amount of the invoice before additions for freight. A 1 1/2% per month service charge will be added to any past due balances.

FREIGHT ALLOWANCE Prepaid freight on orders of \$1500 net or greater to all contiguous US States & Canada or to the nearest Continental US port for all other locations.

MINIMUM ORDER Webstone has no minimum order.

CLAIMS OF SHORTAGE OR VARIANCE Claims of any character must be made within 10 days after receipt of goods. Settlements of any claims are at the discretion of Webstone Company, Inc.

RETURNS Webstone reserves the right to charge a 30% restocking fee on any returned merchandise. Effective January 1, 2016 overstock returns for products that have been discontinued, redesigned, or purchased prior to the last 18 months will no longer be accepted.

ORDER CONFIRMATIONS All orders are subject to acceptance by Webstone Company, Inc. Prices are subject to change without notice.

STANDARD PACKAGING Typically, shipments are made in case and carton quantities. However, Webstone will ship any quantities ordered.

UPC BARCODING 100% of products will be shipped with barcodes if customer specifies the need.

Third Party Approvals and Standards Organizations



The Canadian Standards Association
www.cga.ca



Universal Plumbing Code Certified by the **International Association of Plumbing & Mechanical Officials**
www.iapmo.org



Unless otherwise designated, lead-free certification (NSF/ANSI 61 & NSF/ANSI 372) was performed by Truesdail Laboratories.
www.truesdail.com

NSF/ANSI 61 Drinking Water System Components Health Effects – a standard for “chemical contaminants and impurities that are indirectly imparted to drinking water from products, components, and materials used in drinking water systems”.

CleanBrass™ Webstone's choice of raw material that contains less than 0.25% surface lead in the wetted areas and meets the NSF 61-G and NSF 372 standards for Lead in Drinking Water System Components.

Note:

Third Party Approval Agencies often can approve products to a wide variety of standards; some of the standards may be under the responsibility of another agency. For example, IAPMO can issue approvals to NSF/ANSI 61 standard, as can UL, CSA, etc.

Pressure Ratings

WOG: Water, Oil & Gaseous service. Indicates the maximum pressure of the valve body. Pressure of the valve may be limited by temperature or other features.

WSP: Working Steam Pressure. Indicates the maximum steam pressure of a valve body. This rating is independent from the WOG rating. Typically the WSP rating is lower than the WOG rating.

PRO-CONNECT PRESS™	4-5
Air Separator	5
Ball Valve	4
Pro-Pal® Ball Drain	5
The Isolator® E-X-P™ E2	5
The Isolator® Select	4
The Isolator® w/ Rotating Flange	4
The Isolator® w/ Rotating Flange & Multi-Function Drain	4
Thermostatic Mixing Valve	5
Wall Hung & Combi Boiler Service Valve Kits	5
PRO-CONNECT PP-R PRO™	6-7
Ball Valve	6-7
Pro-Pal® Ball Drain™	6-7
The Isolator® w/ Rotating Flange	6-7
The Isolator® w/ Rotating Flange & Multi-Function Drain	6-7
BALL VALVES	8-14
Brass Ball Valves	8-10
Gas Ball Valves	14
Mini Ball Valves	14
PVC & CPVC Ball Valves	12
Specialty Ball Valves	10-12
Stainless Steel Ball Valves	13
PEX	15
Ball Valve	15
Mini Ball Valve	15
Sillcock	15
Thermostatic Mixing Valve	15
PRO-PAL® SERIES	16-17
Ball Drain™	17
Expansion Tank Pro Service Valve™	16
Purge & Fill™	16
Purge Tee™	16
T-Drain™	16
Union Ball Drain™	17
THE ISOLATOR®	18-20
Circulator Pump Installation Kit	19
Double Flanged Check	20
Select	19
Uni-Flange Ball Valve	18
w/ Drain	18
w/ Rotating Flange	18
w/ Rotating Flange & Multi-Function Drain	19
w/ Round Flange	20
w/ Round Flange & Multi-Function Drain	20
HYDRO-CORE™	22-25
Custom Installations	25
Near Boiler Piping Solutions	22-23
Secondary Circuit Loop Solutions	24
HYDRONIC ACCESSORIES	26-27
Add-a-Gauge Tool	27
Air Separator	26
Pressure Gauge	27
Thermostatic Mixing Valve	26
RADIATOR VALVES & BOILER DRAINS	28-29
Boiler Drains	29
Radiator Valves	28-29
THE ISOLATOR® E-X-P™	30-31
Accessories	31
Complete Tankless Water Heater Service Valve Kit	31
E2™	30
E3™	30
E-X-P™	30
Wall Hung & Combi Boiler Service Valve Kits	31
PRO-CONNECT PRO-PUSH™	32-36
Fittings	32-33
Kits	35
Tools & Accessories	36
Valves	34
PRO-CONNECT UNIVERSAL™	36
LOW PRESSURE VALVES	37-41
Check Valves	37
Gate Valves	38
Globe Valves	38
Hose Bibbs	39
Sillcocks	39
Specialty Valves	41
Supply Stops	40
Unions	41
INDEX	42-43



Pro-Connect Press™ Full Port Forged Brass Ball Valve

w/ Chrome Plated Lever Handle & Adjustable Packing Gland

250 CWP/250° F MAX
ISO 9001



STANDARD BRASS

Certified to NSF/ANSI 61

SIZE	ITEM #	P/CARTON	P/CASE	WT/CASE
Press				
1/2"	81702	5	50	26
3/4"	81703	5	40	32
1"	81704	4	20	26
1 1/4"	81705	5	20	38
1 1/2"	81706	4	16	40
2"	81707	2	8	32
2 1/2"	-	-	-	-
3"	-	-	-	-
4"	-	-	-	-

LEAD-FREE BRASS

Certified to NSF/ANSI 61-G

ITEM #	P/CARTON	P/CASE	WT/CASE
81702W	5	50	26
81703W	5	40	32
81704W	4	20	26
81705W	5	20	38
81706W	4	16	40
81707W	2	8	32
81708W	1	1	8
81709W	1	1	11
81710W	1	1	20

W/ CAP & STRAP, & REVERSIBLE HANDLE

Press x Hose

1/2" x 3/4"	-	-	-	80312W	5	50	30
3/4"	-	-	-	80313W	5	40	33



Pro-Connect Press™ The Isolator® w/ Rotating Flange

Full Port Forged Brass Uni-Flange Ball Valve

w/ Detachable Rotating Flange, Adjustable Packing Gland, Nuts & Bolts

250 CWP/250° F Max
ISO 9001



STANDARD BRASS

SIZE	ITEM #	P/CARTON	P/CASE	WT/CASE
Press x Rotating Flange				
3/4"	81403HV	1	20	27
1"	81404HV	1	20	34
1 1/4"	81405HV	1	20	44
1 1/2"	81406HV	1	10	30
2"	81407HV	1	10	35

Fits standard & high velocity pumps. • 2" Isolators have 1 1/2" port.

WITH 3 3/4" DIAMETER ROUND FLANGE

Press x Rotating Flange				
1 1/2"	81406HV-RF375	1	6	27

WITH 4" DIAMETER ROUND FLANGE

Press x Rotating Flange				
2"	81407HV-RF400	1	6	33

WITH 4 3/4" DIAMETER ROUND FLANGE

Press x Rotating Flange				
2"	81407HV-RF475	1	6	35



Pro-Connect Press™ The Isolator® w/ Rotating Flange & Multi-Function Drain

Full Port Forged Brass Uni-Flange Ball Valve w/ Detachable Rotating Flange,

Multi-Function Hi-Flow Hose Drain, Adjustable Packing Gland, Nuts & Bolts

250 CWP/250° F Max
ISO 9001



STANDARD BRASS

SIZE	ITEM #	P/CARTON	P/CASE	WT/CASE
Press x Rotating Flange				
3/4"	81413HV	1	20	36
1"	81414HV	1	20	42
1 1/4"	81415HV	1	10	29
1 1/2"	81416HV	1	10	37
2"	81417HV	1	10	39

Fits standard & high velocity pumps. • 2" Isolators have 1 1/2" port.

WITH 3 3/4" DIAMETER ROUND FLANGE

Press x Rotating Flange				
1 1/2"	81416HV-RF375	1	6	31

WITH 4" DIAMETER ROUND FLANGE

Press x Rotating Flange				
2"	81417HV-RF400	1	6	39

WITH 4 3/4" DIAMETER ROUND FLANGE

Press x Rotating Flange				
2"	81417HV-RF475	1	6	40



Pro-Connect Press™ The Isolator® Select

Full Port Forged Brass Uni-Flange Ball Valve w/ 4-Way Selectable Flow Path

Plugged FIP Ports, Adjustable Packing Gland, Nuts, Bolts, & Flange Gasket

250 CWP/250° F Max
ISO 9001



STANDARD BRASS

SIZE	ITEM #	P/CARTON	P/CASE	WT/CASE
Press x Rotating Flange				
1"	81424HV	1	10	34

Fits Standard & High Velocity Pumps



Pro-Connect Press™ Pro-Pal® Ball Drain™

250 CWP/250° F Max
ISO 9001

Full Port Forged Brass Ball Valve w/ Hi-Flow Hose Drain, Reversible Handle, & Adjustable Packing Gland



SIZE	STANDARD BRASS				LEAD-FREE BRASS			
	ITEM #	P/CARTON	P/CASE	WT/CASE	ITEM #	P/CARTON	P/CASE	WT/CASE
Press								
1/2"	80612	4	40	38	80612W	4	40	37
3/4"	80613	4	32	39	80613W	4	32	39
1"	80614	2	20	34	80614W	2	20	34
1 1/4"	80615	2	16	42	80615W	2	16	42
1 1/2"	80616	1	8	28	80616W	1	8	28
2"	-	-	-	-	80617W	1	6	33



Pro-Connect Press™ Forged Brass Air Separator

150 PSI
ISO 9001

w/ Removable Vent Head & Coalescing Medium



SIZE	STANDARD BRASS			
	ITEM #	P/CARTON	P/CASE	WT/CASE
Press				
3/4"	78003	1	10	29
1"	78004	1	10	31
1 1/4"	78005	1	10	35
1 1/2"	78006	1	10	75
2"	78007	1	10	84



Pro-Connect Press™ Forged Brass Thermostatic Mixing Valve

150 PSI
ISO 9001

w/ Temperature Locking Handle

For Point of Use, Hydronic Heat, and Water Distribution Systems • **Lead-Free**



SIZE	OUTLET TEMPERATURE RANGE 95-131° F				OUTLET TEMPERATURE RANGE 95-120° F			
	ITEM #	P/CARTON	P/CASE	WT/CASE	ITEM #	P/CARTON	P/CASE	WT/CASE
Press								
1/2"	78102W	1	10	18	78102W-CAN	1	10	18
3/4"	78103W	1	10	20	78103W-CAN	1	10	20
1"	78104W	1	10	21	78104W-CAN	1	10	20
W/ INTEGRAL CHECK VALVE								
1/2"	78202W	1	10	19	78202W-CAN	1	10	18
3/4"	78203W	1	10	20	78203W-CAN	1	10	20
1"	78204W	1	10	21	78204W-CAN	1	10	21



Pro-Connect Press™ The Isolator® E-X-P™ E2

250 CWP
ISO 9001

Tankless Water Heater Service Valve Kit • Hot & Cold Set of Full Port Forged Brass Ball Valves w/ Hi-Flow Hose Drains, Pressure Relief Valve Outlet & Adjustable Packing Glands



SIZE	LEAD-FREE BRASS			
	ITEM #	P/CARTON	P/CASE	WT/CASE
Certified to NSF/ANSI 61-G & 372				
INCLUDES RESIDENTIAL PRESSURE RELIEF VALVE (150 PSI/200,000 BTU)				
IPS Union x Press				
3/4"	84443WPR	1	10	35
1"	84444WPR	1	10	64
INCLUDES LEAD-FREE RESIDENTIAL PRESSURE RELIEF VALVE (150 PSI/200,000 BTU)				
IPS Union x Press				
3/4"	84443WPR-LF	1	10	35
1"	84444WPR-LF	1	10	64
INCLUDES COMMERCIAL GRADE PRESSURE RELIEF VALVE (150 PSI/2.7M BTU) & CLOSE NIPPLE				
IPS Union x Press				
3/4"	84443WPR2	1	10	44
1"	84444WPR2	1	10	73



Pro-Connect Press™ Wall Hung & Combi Boiler Service Valve Kits

250 CWP
ISO 9001

Hot & Cold Set of Full Port Forged Brass Ball Valves w/ Hi-Flow Hose Drains, Pressure Relief Valve Outlet & Adjustable Packing Glands • Includes Residential Pressure Relief Valve (30 PSI/510,000 BTU)



SIZE	LEAD-FREE BRASS			
	ITEM #	P/CARTON	P/CASE	WT/CASE
Certified to NSF/ANSI 61-G & 372				
IPS Union x Press				
3/4"	84443WPR3	1	10	35
1"	84444WPR3	1	10	64

PAIR W/ E-X-P™ TWH KITS FOR COMBI BOILER DOMESTIC HOT WATER CONNECTIONS

WEBSTONE EXCLUSIVE PRODUCTS NOW FOR USE WITH AQUATHERM PP-R PIPING SYSTEMS



aquatherm

- Permanent leak-free heat fusion connections made in seconds
- Compatible with all Aquatherm PP-R piping systems
- Safe, clean, long-lasting, high performance materials
- Suitable for all potable applications
- Available in female metric socket nominal sizes 1/2" to 2"
- Available exclusively at Aquatherm® dealers



Pro-Connect PP-R Pro™ The Isolator® w/ Rotating Flange

Full Port Forged Brass Uni-Flange Ball Valve w/ Detachable Rotating Flange, Adjustable Packing Gland, Nuts & Bolts

355 PSI
ISO 9001**



LEAD-FREE BRASS						
Certified to NSF/ANSI 61 & NSF/ANSI 372						
SIZE*	METRIC SIZE	ITEM #	P/CARTON	P/CASE	WT/CASE	
PP-R x ROTATING FLANGE • COMPATIBLE WITH ALL AQUATHERM® PP-R PIPING SYSTEMS						
3/4"	25	91403WHV	1	20	27	
1"	32	91404WHV	1	20	43	
1 1/4"	40	91405WHV	1	20	52	
1 1/2"	50	91406WHV	1	10	35	
2"	63	91407WHV	1	10	42	

Fits standard & high velocity pumps. • 2" Isolators have 1 1/2" port.



Pro-Connect PP-R Pro™ The Isolator® w/ Rotating Flange & Multi-Function Drain

Full Port Forged Brass Uni-Flange Ball Valve w/ Detachable Rotating Flange, Multi-Function Hi-Flow Hose Drain, Adjustable Packing Gland, Nuts & Bolts

355 PSI
ISO 9001**



LEAD-FREE BRASS						
Certified to NSF/ANSI 61 & NSF/ANSI 372						
SIZE*	METRIC SIZE	ITEM #	P/CARTON	P/CASE	WT/CASE	
PP-R x ROTATING FLANGE • COMPATIBLE WITH ALL AQUATHERM® PP-R PIPING SYSTEMS						
3/4"	25	91413WHV	1	20	36	
1"	32	91414WHV	1	20	44	
1 1/4"	40	91415WHV	1	10	30	
1 1/2"	50	91416WHV	1	10	39	
2"	63	91417WHV	1	10	42	

Fits standard & high velocity pumps. • 2" Isolators have 1 1/2" port.



Pro-Connect PP-R Pro™ Pro-Pal® Ball Drain™

Full Port Forged Brass Ball Valve w/ Hi-Flow Hose Drain, Reversible Handle, & Adjustable Packing Gland

355 PSI
ISO 9001**



LEAD-FREE BRASS						
Certified to NSF/ANSI 61 & NSF/ANSI 372						
SIZE*	METRIC SIZE	ITEM #	P/CARTON	P/CASE	WT/CASE	
PP-R • COMPATIBLE WITH ALL AQUATHERM® PP-R PIPING SYSTEMS						
3/4"	25	90613W	4	32	39	
1"	32	90614W	2	20	39	
1 1/4"	40	90615W	2	16	46	
1 1/2"	50	90616W	1	8	31	
2"	63	90617W	1	6	35	



Pro-Connect PP-R Pro™ Full Port Forged Brass Ball Valve

w/ Chrome Plated Lever Handle & Adjustable Packing Gland

355 PSI
ISO 9001**



LEAD-FREE BRASS						
Certified to NSF/ANSI 61 & NSF/ANSI 372						
SIZE*	METRIC SIZE	ITEM #	P/CARTON	P/CASE	WT/CASE	
PP-R • COMPATIBLE WITH ALL AQUATHERM® PP-R PIPING SYSTEMS						
1/2"	20	91702W	5	50	29	
3/4"	25	91703W	5	40	35	
1"	32	91704W	4	20	32	
1 1/4"	40	91705W	5	20	48	
1 1/2"	50	91706W	4	16	56	
2"	63	91707W	2	8	39	

**Overall valve pressure rating at 73° F. Further restrictions determined by intended operating conditions and limitations specific to the system design. Maximum pressure rating for seat & body alone is 600 PSI.

WEBSTONE EXCLUSIVE PRODUCTS FOR USE WITH ANY PP-R OR PP-RCT PIPING SYSTEM

- Permanent leak-free heat fusion connections made in seconds
- PP-RCT sockets compatible with all PP-R & PP-RCT piping systems†
- Safe, clean, long-lasting, high performance materials
- Suitable for all potable applications
- Available in female metric socket nominal sizes 1/2" to 2"



**Pro-Connect PP-R Pro™
The Isolator® w/ Rotating Flange**

600 PSI
ISO 9001**

Full Port Forged Brass Uni-Flange Ball Valve w/ PP-RCT Socket Connection,
w/ Detachable Rotating Flange, Adjustable Packing Gland, Nuts & Bolts



LEAD-FREE BRASS
Certified to NSF/ANSI 61 & NSF/ANSI 372

SIZE*	METRIC SIZE	ITEM #	P/CARTON	P/CASE	WT/CASE
PP-RCT x ROTATING FLANGE					
3/4"	25	101403WHV	1	20	28
1"	32	101404WHV	1	20	39
1 1/4"	40	101405WHV	1	20	52
1 1/2"	50	101406WHV	1	10	35
2"	63	101407WHV	1	10	42

Fits standard & high velocity pumps. • 2" Isolators have 1 1/2" port



**Pro-Connect PP-R Pro™
The Isolator® w/ Rotating Flange & Multi-Function Drain**

600 PSI
ISO 9001**

Full Port Forged Brass Uni-Flange Ball Valve w/ PP-RCT Socket Connection, Detachable Rotating Flange,
Multi-Function Hi-Flow Hose Drain, Adjustable Packing Gland, Nuts & Bolts



LEAD-FREE BRASS
Certified to NSF/ANSI 61 & NSF/ANSI 372

SIZE*	METRIC SIZE	ITEM #	P/CARTON	P/CASE	WT/CASE
PP-RCT x ROTATING FLANGE					
3/4"	25	101413WHV	1	20	36
1"	32	101414WHV	1	20	44
1 1/4"	40	101415WHV	1	10	30
1 1/2"	50	101416WHV	1	10	39
2"	63	101417WHV	1	10	42



Fits standard & high velocity pumps. • 2" Isolators have 1 1/2" port



**Pro-Connect PP-R Pro™
Pro-Pal® Ball Drain™**

600 PSI
ISO 9001**

Full Port Forged Brass Ball Valve w/ PP-RCT Socket Connections, Hi-Flow Hose Drain,
Reversible Handle, & Adjustable Packing Gland



LEAD-FREE BRASS
Certified to NSF/ANSI 61 & NSF/ANSI 372

SIZE*	METRIC SIZE	ITEM #	P/CARTON	P/CASE	WT/CASE
PP-RCT					
3/4"	25	100613W	4	32	39
1"	32	100614W	2	20	39
1 1/4"	40	100615W	2	16	46
1 1/2"	50	100616W	1	8	31
2"	63	100617W	1	6	35



Pro-Connect PP-R Pro™ Full Port Forged Brass Ball Valve

600 PSI
ISO 9001**

w/ PP-RCT Socket Connections, Chrome Plated Lever Handle & Adjustable Packing Gland



LEAD-FREE BRASS
Certified to NSF/ANSI 61 & NSF/ANSI 372

SIZE*	METRIC SIZE	ITEM #	P/CARTON	P/CASE	WT/CASE
PP-RCT					
1/2"	20	101702W	5	50	29
3/4"	25	101703W	5	40	35
1"	32	101704W	4	20	32
1 1/4"	40	101705W	5	20	48
1 1/2"	50	101706W	4	16	56
2"	63	101707W	2	8	39

†In accordance with piping manufacturer's installation and warranty requirements.

**PP-RCT Sockets are manufactured based on metric units of measurement. Imperial nominal diameter is provided as reference only.

**Valve seat/body maximum pressure rating at 100° F. Overall valve pressure rating is determined by intended operating conditions and limitations specific to the system design.

CONNECTIONS FOR EVERY JOB



Full Port Forged Brass Ball Valve
w/ Adjustable Packing Gland

600 WOG/150 WSP (400 WOG/125 WSP 2 1/2" - 4")
ISO 9001



SIZE	STANDARD BRASS				LEAD-FREE BRASS			
	ITEM #	P/CARTON	P/CASE	WT/CASE	ITEM #	P/CARTON	P/CASE	WT/CASE
IPS								
w/ Chrome Plated Lever Handle								
1/4"	41700	10	100	26	41700W	10	100	26
3/8"	41701	10	100	28	41701W	10	100	28
1/2"	41702	10	80	31	41702W	10	80	30
3/4"	41703	10	60	34	41703W	10	60	34
1"	41704	6	36	38	41704W	6	36	37
1 1/4"	41705	6	24	34	41705W	6	24	34
1 1/2"	41706	2	16	35	41706W	2	16	35
2"	41707	2	12	37	41707W	2	12	37
2 1/2"	41708	1	6	42	41708W	1	6	44
3"	41709	1	4	36	41709W	1	4	35
4"	41710	1	2	30	41710W	1	2	29

Certifications apply to 1/4"-2" Only

Certifications apply to 1/4"-2" Only



SIZE	STANDARD BRASS				LEAD-FREE BRASS			
	ITEM #	P/CARTON	P/CASE	WT/CASE	ITEM #	P/CARTON	P/CASE	WT/CASE
w/ 304 Stainless Steel Handle								
1/2"	41702SSL	10	80	30	41702WSSL	10	80	30
3/4"	41703SSL	10	60	34	41703WSSL	10	60	35
1"	41704SSL	6	36	38	41704WSSL	6	36	38
1 1/4"	41705SSL	6	24	33	41705WSSL	6	24	33
1 1/2"	41706SSL	2	16	39	41706WSSL	2	16	35
2"	41707SSL	2	12	37	41707WSSL	2	12	39
w/ Wing Style "T" Handle								
1/2"	41702T	10	80	32	41702WT	10	80	32
3/4"	41703T	10	60	34	41703WT	10	60	37
1"	41704T	6	36	43	41704WT	6	36	39
w/ 304 Stainless Steel Wing Style "T" Handle								
1/2"	41702SSW	10	80	38	41702WSSW	10	80	38
3/4"	41703SSW	10	60	35	41703WSSW	10	60	35
1"	41704SSW	6	48	54	41704WSSW	6	48	51



SIZE	STANDARD BRASS				LEAD-FREE BRASS			
	ITEM #	P/CARTON	P/CASE	WT/CASE	ITEM #	P/CARTON	P/CASE	WT/CASE
SWT								
w/ Chrome Plated Lever Handle								
1/2"	51702	10	80	26	51702W	10	80	25
3/4"	51703	10	60	32	51703W	10	60	32
1"	51704	6	36	34	51704W	6	36	34
1 1/4"	51705	6	24	32	51705W	6	24	31
1 1/2"	51706	2	24	52	51706W	2	16	48
2"	51707	2	12	37	51707W	2	12	37
2 1/2"	51708	1	8	53	51708W	1	8	51
3"	51709	1	3	25	51709W	1	4	33
4"	51710	1	2	35	51710W	1	2	41

Certifications apply to 1/4"-2" Only

Certifications apply to 1/4"-2" Only



SIZE	STANDARD BRASS				LEAD-FREE BRASS			
	ITEM #	P/CARTON	P/CASE	WT/CASE	ITEM #	P/CARTON	P/CASE	WT/CASE
w/ 304 Stainless Steel Handle								
1/2"	51702SSL	10	80	25	51702WSSL	10	80	25
3/4"	51703SSL	10	60	32	51703WSSL	10	60	32
1"	51704SSL	6	36	33	51704WSSL	6	36	33
1 1/4"	51705SSL	6	24	30	51705WSSL	6	24	31
1 1/2"	51706SSL	2	24	52	51706WSSL	2	16	35
2"	51707SSL	2	12	37	51707WSSL	2	12	37
w/ Wing Style "T" Handle								
1/2"	51702T	10	80	28	51702WT	10	80	26
3/4"	51703T	10	60	35	51703WT	10	60	33
1"	51704T	6	36	36	51704WT	6	36	34
w/ 304 Stainless Steel Wing Style "T" Handle								
1/2"	51702SSW	10	80	41	51702WSSW	10	80	41
3/4"	51703SSW	10	60	42	51703WSSW	10	60	46
1"	51704SSW	6	36	41	51704WSSW	6	36	46

BALL VALVES

GUARANTEED FOR LIFE



Full Port Forged Brass Ball Valve ISO 9001
w/ Adjustable Packing Gland



STANDARD BRASS					LEAD-FREE BRASS			
SIZE	ITEM #	P/CARTON	P/CASE	WT/CASE	ITEM #	P/CARTON	P/CASE	WT/CASE
ASTM F1960 PEX								
w/ Stainless Steel Wing Style "T" Handle								
1/2"	-	-	-	-	31702WSSW	10	80	27
3/4"	-	-	-	-	31703WSSW	10	60	30
1"	-	-	-	-	31704WSSW	6	36	32

3170W Series is Full Flow

STANDARD BRASS					LEAD-FREE BRASS			
SIZE	ITEM #	P/CARTON	P/CASE	WT/CASE	ITEM #	P/CARTON	P/CASE	WT/CASE
PRESS								
w/ Chrome Plated Lever Handle								
1/2"	81702	5	50	26	81702W	5	50	26
3/4"	81703	5	40	32	81703W	5	40	32
1"	81704	4	20	26	81704W	4	20	26
1 1/4"	81705	5	20	38	81705W	5	20	38
1 1/2"	81706	4	16	40	81706W	4	16	40
2"	81707	2	8	32	81707W	2	8	32
2 1/2"	-	-	-	-	81708W	1	1	8
3"	-	-	-	-	81709W	1	1	11
4"	-	-	-	-	81710W	1	1	20

81706W CERTIFIED TO NSF/ANSI 61-8



LEAD-FREE BRASS						
SIZE*	METRIC SIZE	ITEM #	P/CARTON	P/CASE	WT/CASE	
Certified to NSF/ANSI 61 & NSF/ANSI 372						
PP-R • COMPATIBLE WITH ALL AQUATHERM® PP-R PIPING SYSTEMS						
w/ Chrome Plated Lever Handle						
1/2"	20	91702W	5	50	29	
3/4"	25	91703W	5	40	35	
1"	32	91704W	4	20	32	
1 1/4"	40	91705W	5	20	48	
1 1/2"	50	91706W	4	16	56	
2"	63	91707W	2	8	39	

**Overall valve pressure rating at 73° F. Further restrictions determined by intended operating conditions and limitations specific to the system design. Maximum pressure rating for seat & body alone is 600 PSI.



LEAD-FREE BRASS						
SIZE*	METRIC SIZE	ITEM #	P/CARTON	P/CASE	WT/CASE	
Certified to NSF/ANSI 61 & NSF/ANSI 372						
PP-RCT						
w/ Chrome Plated Lever Handle						
1/2"	20	101702W	5	50	29	
3/4"	25	101703W	5	40	35	
1"	32	101704W	4	20	32	
1 1/4"	40	101705W	5	20	48	
1 1/2"	50	101706W	4	16	56	
2"	63	101707W	2	8	39	

**PP-RCT Sockets are manufactured based on metric units of measurement. Imperial nominal diameter is provided as reference only. **Valve seat/body maximum pressure rating at 100° F. Overall valve pressure rating is determined by intended operating conditions and limitations specific to the system design.

Pro-Connect ProPush™ Ball Valve 200 PSI/200° F ISO 9001
Pro-Connect ProPush™ Full Port Forged Dezincification Resistant Brass Ball Valve
w/ Adjustable Packing Gland • For Connection to Copper, CPVC or PEX • Lead-Free



INDIVIDUALLY PACKED					BULK PACKED			
SIZE	ITEM #	P/CARTON	P/CASE	WT/CASE	ITEM #	P/CARTON	P/CASE	WT/CASE
Certified to ASSE 1061, NSF/ANSI 61-G, IAPMO/ANSI Z1157								
Certified to ASSE 1061, NSF/ANSI 61-G, IAPMO/ANSI Z1157								
1/2"	62702W	10	100	43	62702W-B	12	72	32
3/4"	62703W	10	100	62	62703W-B	12	48	31
1"	62704W	5	50	55	62704W-B	6	24	28

BALL VALVES

Full Port Nickel Plated Forged Brass Ball Valve

w/ 304 Stainless Steel Lever Handle & Adjustable Packing Gland

600 WOG/150 WSP
ISO 9001



SIZE
IPS

1/4"
3/8"
1/2"
3/4"
1"
1 1/4"
1 1/2"
2"

ITEM #

40800W
40801W
40802W
40803W
40804W
40805W
40806W
40807W

LEAD-FREE BRASS

Certified to NSF/ANSI 61-G

P/CARTON

P/CASE

WT/CASE

20

120

42

20

120

36

20

120

53

14

84

55

8

48

52

6

36

56

4

24

58

2

16

55

Standard Port Forged Brass Ball Valve

w/ Adjustable Packing Gland

600 WOG/125 WSP
ISO 9001



SIZE
IPS

1/4"
3/8"
1/2"
3/4"
1"
1 1/4"
1 1/2"
2"
2 1/2"
3"
4"

STANDARD BRASS

ITEM #

P/CARTON

P/CASE

WT/CASE

41820
41821
41822
41823
41824
41825
41826
41827
41828
41829
41830

10
10
10
10
6
4
2
2
2
1
1

120
120
120
80
48
32
24
16
4
3
2

37
35
44
38
43
39
42
39
22
25
26

LEAD-FREE BRASS

Certified to NSF/ANSI 61-G

ITEM #

P/CARTON

P/CASE

WT/CASE

41820W
41821W
41822W
41823W
41824W
41825W
41826W
41827W
41828W
41829W
41830W

10
10
10
10
6
4
2
2
2
1
1

120
120
120
80
48
32
24
16
4
3
2

37
35
44
38
43
37
42
39
22
24
26

CSA 1/2-2" Only. Certifications do not apply to 1/4"

CSA 1/2-2" Only

SPECIALTY BALL VALVES

Full Flow Forged Brass Ball Valve

w/ Adjustable Packing Gland & Stainless Steel Wing Style "T" Handle

400 WOG



SIZE

ASTM F1960 PEX x FIP

1/2"
3/4"
1"

ITEM #

34702WSSW
34703WSSW
34704WSSW

P/CARTON

10
10
6

P/CASE

80
60
36

WT/CASE

28
30
32

Certified to NSF 14, ANSI Z1157, NSF/ANSI-61, & NSF/ANSI-372

Full Flow Forged Brass Ball Valve

w/ Wing Handle & Adjustable Packing Gland

160 WOG
ISO 9001



SIZE

ASTM F1807 PEX x SWT

1/2"

ITEM #

50682

P/CARTON

10

P/CASE

100

WT/CASE

24

STANDARD BRASS

Full Port Forged Brass Ball Valve

3 Way L-Port w/ Reversible Handle & Adjustable Packing Gland

600 WOG/150 WSP
ISO 9001



SIZE

IPS

1/2"
3/4"
1"

ITEM #

40642
40643
40644

P/CARTON

15
10
6

P/CASE

60
40
24

WT/CASE

33
33
34

STANDARD BRASS

BALL VALVES

Full Port Forged Brass Ball Valve

w/ 1/4" Threaded Gauge Hole (Plugged), Reversible Handle, & Adjustable Packing Gland

600 WOG/150 WSP
ISO 9001



SIZE IPS	ITEM #	STANDARD BRASS		WT/CASE
		P/CARTON	P/CASE	
1/2"	41722	10	80	42
3/4"	41723	10	60	42
1"	41724	6	48	55
1 1/4"	41725	4	32	55
1 1/2"	41726	2	24	64
2"	41727	2	16	60

Forged Brass Ball Valve

w/ Bleeder, Reversible Handle, & Adjustable Packing Gland

600 WOG/150 WSP
ISO 9001



SIZE IPS	ITEM #	LEAD-FREE BRASS		WT/CASE
		P/CARTON	P/CASE	
1/2"	40622W	15	120	59
3/4"	40623W	12	48	35
1"	40624W	8	32	37
SWT				
1/2"	50622W	25	100	48
3/4"	50623W	10	40	30
1"	50624W	6	24	28

Full Port Forged Brass Ball Valve

w/ Reversible Handle & Adjustable Packing Gland

600 WOG/150 WSP
ISO 9001



SIZE MIP x FIP	ITEM #	LEAD-FREE BRASS		WT/CASE
		P/CARTON	P/CASE	
1/4"	40530W	12	96	34
3/8"	40531W	12	96	32
1/2"	40532W	12	96	44
3/4"	40533W	10	60	43
1"	40534W	6	48	54

Forged Brass Ball Valve

w/ Compression Ends & Adjustable Packing Gland

600 WOG/150 WSP
ISO 9001



SIZE Compression	ITEM #	LEAD-FREE BRASS		WT/CASE
		P/CARTON	P/CASE	
1/2"	40632W	25	100	55
3/4"	40633W	15	60	50
1"	40634W	10	40	51

Full Port Forged Brass Ball Valve

w/ Cap & Strap, Reversible Handle, & Adjustable Packing Gland

600 WOG/150 WSP
ISO 9001



SIZE FIP x Hose	ITEM #	LEAD-FREE BRASS		WT/CASE
		P/CARTON	P/CASE	
1/2" x 3/4"	40312W	10	60	29
3/4"	40313W	10	60	41
SWT x Hose				
1/2" x 3/4"	50312W	10	100	48
3/4"	50313W	10	60	41
Press x Hose				
1/2" x 3/4"	80312W	5	50	30
3/4"	80313W	5	40	33



Full Flow Forged Brass Silcock

Nickel Plated w/ 1/4 Turn Action & Stainless Steel Lever Handle

125 WOG
ISO 9001



SIZE ASTM F1960 PEX Flange x 3/4" Male Hose	ITEM #	P/CARTON	P/CASE	WT/CASE
1/2"	33202WSSL	12	72	58

Forged Brass Sillcock

Nickel Plated w/ 1/4 Turn Handle

125 WOG
ISO 9001



LEAD-FREE BRASS

SIZE	ITEM #	P/CARTON	P/CASE	WT/CASE
FIP Flange x Hose				
1/2"	30202W	12	72	42
3/4"	30203W	12	72	58

Forged Brass Hose Bibb

w/ Ball Valve Action

125 WOG
ISO 9001



LEAD-FREE BRASS

Certified to NSF/ANSI 61-G

SIZE	ITEM #	P/CARTON	P/CASE	WT/CASE
MIP x Hose				
1/2"	30314W	12	72	34
3/4"	30316W	12	72	38

*1/2 MIP or SWT x HOSE

Brass Hose Bibb

No Kink, w/ 1/4 Turn Handle

125 WOG
ISO 9001



LEAD-FREE BRASS

Certified to NSF/ANSI 61-G

SIZE	ITEM #	P/CARTON	P/CASE	WT/CASE
MIP x Hose				
1/2"	30218W	12	72	22
3/4"	30219W	12	72	25

PVC & CPVC BALL VALVES

Full Port PVC Ball Valve

Fits Schedule 40 & 80 Pipe — White

230 PSI @ 73.4° F (6" 90 PSI @ 73.4° F)
ISO 9001



SIZE	ITEM #	P/CARTON	P/CASE	WT/CASE
Socket Ends				
1/2"	03822	1	195	35
3/4"	03823	1	120	35
1"	03824	1	83	37
1 1/4"	03825	1	56	38
1 1/2"	03826	1	12	12
2"	03827	1	25	39
2 1/2"	03828	1	16	67
3"	03829	1	6	23
4"	03830	1	6	58
6"	03831	1	1	21
IPS				
1/2"	03922	1	195	47
3/4"	03923	1	120	42
1"	03924	1	83	45
1 1/4"	03925	1	12	10
1 1/2"	03926	1	36	35
2"	03927	1	25	40
True Union (Includes Both IPS & Socket Ends)				
1/2"	04602	1	72	31
3/4"	04603	1	60	39
1"	04604	1	24	17
1 1/4"	04605	1	12	13
1 1/2"	04606	1	12	26
2"	04607	1	12	32

03829 not ISO

Full Port CPVC Ball Valve

Fits Schedule 40 & 80 CPVC Tubing

230 PSI @ 194° F
ISO 9001



SIZE	ITEM #	P/CARTON	P/CASE	WT/CASE
Socket Ends				
1/2"	03722	1	100	15
3/4"	03723	1	100	20
1"	03724	1	100	29
1 1/4"	03725	1	100	58
1 1/2"	03726	1	48	36
2"	03727	1	24	31

Made w/ NSF Certified Polymer

Full Port 316 Stainless Steel Ball Valve

Seal Welded w/ 304 Stainless Steel Locking Handle, & Adjustable Packing Gland

2000 WOG
ISO 9001



SIZE IPS	ITEM #	P/CARTON	P/CASE	WT/CASE
1/4"	43710	12	48	28
1/2"	43712	10	30	23
3/4"	43713	9	27	49
1"	43714	6	18	52
2"	43717	2	6	52

Standard Port 316 Stainless Steel Ball Valve

Seal Welded w/ 304 Stainless Steel Locking Handle, & Adjustable Packing Gland

2000 WOG



SIZE IPS	ITEM #	P/CARTON	P/CASE	WT/CASE
1"	43814	9	27	49
2"	43817	2	8	45

Full Port 316 Stainless Steel Ball Valve

3 Piece Investment Cast w/ 304 Stainless Steel Locking Handle, & Adjustable Packing Gland

1000 WOG/150 WSP
ISO 9001



SIZE IPS	ITEM #	P/CARTON	P/CASE	WT/CASE
1/2"	43702	2	50	64
3/4"	43703	2	40	75
1"	43704	2	30	73
1 1/4"	43705	2	16	59
1 1/2"	43706	2	10	47
2"	43707	2	8	59

Full Port 316 Stainless Steel Ball Valve

2 Piece Investment Cast w/ 304 Stainless Steel Locking Handle, & Adjustable Packing Gland

1000 WOG/150 WSP
ISO 9001



SIZE IPS	ITEM #	P/CARTON	P/CASE	WT/CASE
1/4"	43720	2	80	42
3/8"	43721	2	80	39
1/2"	43722	2	60	44
3/4"	43723	2	40	44
1"	43724	2	40	67
1 1/4"	43725	2	30	78
1 1/2"	43726	2	16	63
2"	43727	2	10	51
W/ 304 STAINLESS STEEL OVAL HANDLE				
1/2"	43722-0H	1	40	34
3/4"	43723-0H	1	30	36
1"	43724-0H	1	20	36

Standard Port 316 Stainless Steel Ball Valve

1 Piece Investment Cast w/ 304 Stainless Steel Locking Handle, & Adjustable Packing Gland

1000 WOG/150 WSP
ISO 9001



SIZE IPS	ITEM #	P/CARTON	P/CASE	WT/CASE
1/4"	43900	4	200	30
3/8"	43901	4	200	44
1/2"	43902	2	100	37
3/4"	43903	2	80	46
1"	43904	2	50	46
1 1/4"	43905	2	40	55
1 1/2"	43906	2	30	58
2"	43907	2	30	86

Forged Brass Gas Ball Valve

1/2 TO 175 WOG
ISO 9001



SIZE	STANDARD BRASS			
	ITEM #	P/CARTON	P/CASE	WT/CASE
IPS				
3/8"	22561	12	144	32
1/2"	22562	12	144	48
3/4"	22563	12	144	63
1"	22564	6	72	57
Flare x FIP				
3/8" x 1/2"	22521	10	120	49
1/2"	22522	10	120	42
5/8" x 3/4"	21526	6	96	58
				22522
Flare				
3/8"	21550	12	144	55
1/2"	21551	12	144	55
				Certifications do not apply to 21550
Flare x MIP				
3/8" x 1/2"	21571	12	144	50
1/2"	21572	12	144	45

See Pages 8–10 for other brass ball valves that carry CSA approval for gas applications.

MINI BALL VALVES

Full Port Forged Brass Ball Valve Pet Cock Style

600 WOG/125 WSP
ISO 9001



SIZE	STANDARD BRASS			
	ITEM #	P/CARTON	P/CASE	WT/CASE
FIP x MIP				
1/8"	41685	10	100	18
1/4" x 1/8"	41686	10	100	9
1/4"	41687	10	100	17
FIP				
1/8"	41698	10	100	17
1/4"	41699	10	100	16

Chrome Plated Extruded Brass Mini Ball Valve Pet Cock Style

110 WOG NON-SHOCK



SIZE	STANDARD BRASS			
	ITEM #	P/CARTON	P/CASE	WT/CASE
MIP x FIP				
1/8"	40790	50	300	54
1/4"	40791	50	300	54
3/8"	40792	50	300	45
1/2"	40798	30	300	66
IPS				
1/8"	40793	12	144	23
1/4"	40794	50	400	80
3/8"	40795	50	300	51
1/2"	40796	5	500	120

Chrome Plated Extruded Brass Mini Ball Valve Hex Body

110 WOG NON-SHOCK
ISO 9001



SIZE	STANDARD BRASS			
	ITEM #	P/CARTON	P/CASE	WT/CASE
ASTM F1807 PEX				
1/2"	40782	12	144	29

Full Flow Forged Brass Ball Valve

w/ Adjustable Packing Gland & Stainless Steel Wing Style "T" Handle

400 WOG



LEAD-FREE BRASS

Certified to NSF 14, ANSI Z1157, NSF/ANSI-61, & NSF/ANSI-372

SIZE	ITEM #	P/CARTON	P/CASE	WT/CASE
ASTM F1960 PEX				
1/2"	31702WSSW	10	80	27
3/4"	31703WSSW	10	60	30
1"	31704WSSW	6	36	32
ASTM F1960 PEX x FIP				
1/2"	34702WSSW	10	80	28
3/4"	34703WSSW	10	60	30
1"	34704WSSW	6	36	32

Full Flow Forged Brass Silcock

Nickel Plated w/ 1/4 Turn Action & Stainless Steel Lever Handle

**125 WOG
ISO 9001**



LEAD-FREE BRASS

SIZE	ITEM #	P/CARTON	P/CASE	WT/CASE
ASTM F1960 PEX Flange x 3/4" Male Hose				
1/2"	33202WSSL	12	72	58

Full Flow Forged Brass Ball Valve

w/ Wing Handle & Adjustable Packing Gland

**160 WOG
ISO 9001**



STANDARD BRASS

SIZE	ITEM #	P/CARTON	P/CASE	WT/CASE
ASTM F1807 PEX x SWT				
1/2"	50682	10	100	24

Chrome Plated Extruded Brass Mini Ball Valve

Hex Body

**110 WOG NON-SHOCK
ISO 9001**



STANDARD BRASS

SIZE	ITEM #	P/CARTON	P/CASE	WT/CASE
ASTM F1807 PEX				
1/2"	40782	12	144	29

Forged Brass Thermostatic Mixing Valve

w/ Temperature Locking Handle • For Point of Use, Hydronic Heat, and Water Distribution Systems • **Lead-Free**

**150 PSI
ISO 9001**



OUTLET TEMPERATURE RANGE 95-131° F

OUTLET TEMPERATURE RANGE 95-120° F

SIZE	ITEM #	P/CARTON	P/CASE	WT/CASE	ITEM #	P/CARTON	P/CASE	WT/CASE
ASTM F1807 PEX								
1/2"	73102W	1	10	17	73102W-CAN	1	10	14
3/4"	73103W	1	10	18	73103W-CAN	1	10	14
W/ INTEGRAL CHECK VALVE								
ASTM F1807 PEX								
1/2"	73202W	1	10	17	73202W-CAN	1	10	14
3/4"	73203W	1	10	17	73203W-CAN	1	10	14





STEP SAVING VALVES FOR THE PROFESSIONAL



Pro-Pal® Purge & Fill™
Full Port Forged Brass Ball Valve w/ (2) Hi-Flow Hose Drains,
Reversible Handle, & Adjustable Packing Gland

**600 WOG
ISO 9001**



SIZE	STANDARD BRASS			
	ITEM #	P/CARTON	P/CASE	WT/CASE
IPS				
3/4"	48613	1	12	19
1"	48614	1	12	25
1 1/4"	48615	1	12	37
1 1/2"	48616	1	12	48
SWT				
3/4"	58613	1	12	22
1"	58614	1	12	25
1 1/4"	58615	1	12	37
1 1/2"	58616	1	12	55



Pro-Pal® Purge Tee™
Full Port Forged Brass Ball Valve — Primary/Secondary Loop Purge Tee,
Reversible Handle & Adjustable Packing Gland

**600 WOG
ISO 9001**



SIZE	STANDARD BRASS			
	ITEM #	P/CARTON	P/CASE	WT/CASE
SWT (1" Primary Loop)				
1" x 3/4"	58643	1	12	22
1" x 1"	58644	1	12	23
SWT (1 1/4" Primary Loop)				
1 1/4" x 3/4"	58653	1	12	38
1 1/4" x 1"	58654	1	12	37
1 1/4" x 1 1/4"	58655	1	12	36



Pro-Pal® T-Drain™
Full Port Forged Brass Fitting w/ Hi-Flow Hose Drain

**600 WOG
ISO 9001**



SIZE	LEAD-FREE BRASS			
	ITEM #	P/CARTON	P/CASE	WT/CASE
Certified to NSF/ANSI 61-G				
SWT				
1/2"	50672W	8	80	41
3/4"	50673W	6	48	38
1"	50674W	4	40	35
1 1/4"	50675W	4	40	42
1 1/2"	50676W	2	24	33
2"	50677W	2	20	33



Pro-Pal® Expansion Tank Pro Service Valve™
Full Port Forged Brass Ball Valve w/ Hi-Flow Hose Drain

**600 WOG
ISO 9001**



SIZE	STANDARD BRASS			
	ITEM #	P/CARTON	P/CASE	WT/CASE
FIP x MIP x FIP x Hose				
1/2"	41672	1	30	28

**IDEAL FOR USE WITH THE
WEBSTONE AIR SEPARATOR**





Pro-Pal® Ball Drain™
Full Port Forged Brass Ball Valve w/ Hi-Flow Hose Drain,
Reversible Handle, & Adjustable Packing Gland

600 WOG
ISO 9001



AVAILABLE W/
LEAD-FREE
CLEAN
BRASS

STANDARD BRASS

LEAD-FREE BRASS

SIZE	ITEM #	P/CARTON	P/CASE	WT/CASE
IPS				
1/2"	40612	6	36	31
3/4"	40613	6	36	39
1"	40614	4	24	38
1 1/4"	40615	2	12	26
1 1/2"	40616	2	12	36
2"	40617	1	6	28
SWT				
1/2"	50612	6	36	28
3/4"	50613	6	36	38
1"	50614	4	24	37
1 1/4"	50615	2	12	26
1 1/2"	50616	2	12	40
2"	50617	1	6	31
SWT x IPS				
1/2"	54612	6	36	29
3/4"	54613	6	36	39
1"	54614	4	24	36
Press				
1/2"	80612	4	40	38
3/4"	80613	4	32	39
1"	80614	2	20	34
1 1/4"	80615	2	16	42
1 1/2"	80616	1	8	28
2"	-	-	-	-

Certified to NSF/ANSI 61 & NSF/ANSI 372

ITEM #	P/CARTON	P/CASE	WT/CASE
40612W	6	36	31
40613W	6	36	39
40614W	4	24	37
40615W	2	12	26
40616W	2	8	25
40617W	1	6	28
50612W	6	36	28
50613W	6	36	38
50614W	4	24	36
50615W	2	12	26
50616W	2	8	26
50617W	1	6	29
54612W	6	36	29
54613W	6	36	38
54614W	4	24	36
80612W	4	40	37
80613W	4	32	39
80614W	2	20	34
80615W	2	16	42
80616W	1	8	28
80617W	1	6	33

LEAD-FREE BRASS

Certified to NSF/ANSI 61 & NSF/ANSI 372

LEAD-FREE
CLEAN
BRASS

SIZE†	METRIC SIZE	ITEM #	P/CARTON	P/CASE	WT/CASE
PP-R • Compatible with all Aquatherm® PP-R piping systems					
3/4"	25	90613W	4	32	39
1"	32	90614W	2	20	39
1 1/4"	40	90615W	2	16	46
1 1/2"	50	90616W	1	8	31
2"	63	90617W	1	6	35
PP-RCT					
3/4"	25	100613W	4	32	39
1"	32	100614W	2	20	39
1 1/4"	40	100615W	2	16	46
1 1/2"	50	100616W	1	8	31
2"	63	100617W	1	6	35

*Overall valve pressure rating at 73° F. Further restrictions determined by intended operating conditions and limitations specific to the system design. Maximum pressure rating for seat & body alone is 600 PSI.
 †Valve seat/body maximum pressure rating at 100° F. Overall valve pressure rating is determined by intended operating conditions and limitations specific to the system design.
 †PP-R & PP-RCT Sockets are manufactured based on metric units of measurement. Imperial nominal diameter is provided as reference only.



Pro-Pal® Union Ball Drain™
Full Port Forged Brass Ball Valve w/ Single Union End, Hi-Flow Hose Drain,
Reversible Handle, & Adjustable Packing Gland

600 WOG
ISO 9001



AVAILABLE W/
LEAD-FREE
CLEAN
BRASS

STANDARD BRASS

LEAD-FREE BRASS

SIZE	ITEM #	P/CARTON	P/CASE	WT/CASE
IPS				
3/4"	40433	6	24	40
1"	40434	4	16	35
1 1/4"	40435	2	12	39
1 1/2"	40436	2	12	55
SWT				
3/4"	50433	6	24	39
1"	50434	4	16	35
1 1/4"	50435	2	12	37
1 1/2"	50436	2	12	56

Certified to NSF/ANSI 61 & NSF/ANSI 372

ITEM #	P/CARTON	P/CASE	WT/CASE
40433W	6	24	39
40434W	4	16	35
40435W	2	12	37
40436W	2	8	37
50433W	6	24	38
50434W	4	16	30
50435W	2	12	37
50436W	2	8	37

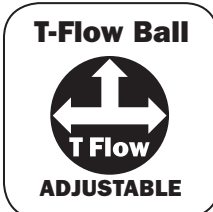

Adjustable stem directs flow into the hi-flow hose drain from either side of the ball

DRAINING FROM ABOVE BALL

DRAINING FROM BELOW BALL

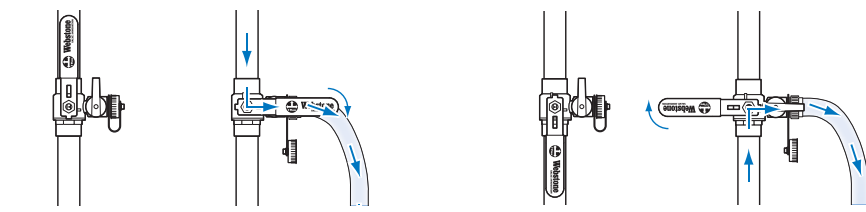

Normal Operation System Purging Normal Operation System Purging



The Isolator® Uni-Flange Ball Valve

Full Port Forged Brass Ball Valve w/ Adjustable Packing Gland, Nuts & Bolts

**600 WOG
ISO 9001**



STANDARD BRASS				
SIZE	ITEM #	P/CARTON	P/CASE	WT/CASE
IPS × Flange				
1/2"	40402	1	20	23
3/4"	40403	1	20	28
1"	40404	1	20	34
1 1/4"	40405	1	20	40
1 1/2"	40406	1	20	58
2"	40407HV	1	10	37
SWT × Flange				
1/2"	50402	1	20	30
3/4"	50403	1	20	27
1"	50404	1	20	33
1 1/4"	50405	1	20	40
1 1/2"	50406	1	20	57
2"	50407HV	1	10	39

Also available for High Velocity Pumps – to order, add HV onto the end of the part #. • 2" Available in High Velocity only, also fits standard size pumps. 2" Isolators have 1 1/2" port.



The Isolator® w/ Drain

Full Port Forged Brass Uni-Flange Ball Valve w/ Hi-Flow Hose Drain, Adjustable Packing Gland, Nuts & Bolts

600 WOG • ISO 9001



STANDARD BRASS				
SIZE	ITEM #	P/CARTON	P/CASE	WT/CASE
IPS × Flange				
3/4"	40413	1	20	41
1"	40414	1	20	48
1 1/4"	40415	1	20	61
1 1/2"	40416	1	10	40
2"	40417HV	1	10	56
SWT × Flange				
3/4"	50413	1	20	40
1"	50414	1	20	49
1 1/4"	50415	1	20	62
1 1/2"	50416	1	10	42
2"	50417HV	1	10	56

Also available for High Velocity Pumps – to order, add HV onto the end of the part #. • 2" Available in High Velocity only, also fits standard size pumps. • 2" Isolators have 1 1/2" port.



The Isolator® w/ Rotating Flange

Full Port Forged Brass Uni-Flange Ball Valve w/ Detachable Rotating Flange, Adjustable Packing Gland, Nuts & Bolts

**600 WOG
ISO 9001**



SIZE	STANDARD BRASS					LEAD-FREE BRASS		
	ITEM #	P/CARTON	P/CASE	WT/CASE	ITEM #	P/CARTON	P/CASE	WT/CASE
IPS × Rotating Flange								
3/4"	41403	1	20	26	41403W	2	20	26
1"	41404	1	20	33	41404W	2	20	34
1 1/4"	41405	1	20	40	41405W	2	20	44
1 1/2"	41406	1	20	53	41406W	2	10	31
2"	-	-	-	-	41407WHV	1	10	33
SWT × Rotating Flange								
3/4"	51403	1	20	24	51403W	2	20	26
1"	51404	1	20	33	51404W	2	20	34
1 1/4"	51405	1	20	40	51405W	2	20	44
1 1/2"	51406	1	20	57	51406W	2	10	32
2"	-	-	-	-	51407WHV	1	10	33
Press × Rotating Flange								
3/4"	81403HV	1	20	27	-	-	-	-
1"	81404HV	1	20	34	-	-	-	-
1 1/4"	81405HV	1	20	44	-	-	-	-
1 1/2"	81406HV	1	10	30	-	-	-	-
2"	81407HV	1	10	35	-	-	-	-

AVAILABLE W/ CLEAN BRASS

Certified to NSF/ANSI 61-G

250 CWP/250° F Max



PRO-CONNECT PRESS



PRO-CONNECT PP-R

aquatherm



PRO-CONNECT PP-R

LEAD-FREE BRASS						
Certified to NSF/ANSI 61 & NSF/ANSI 372						
SIZE†	METRIC SIZE	ITEM #	P/CARTON	P/CASE	WT/CASE	
PP-R × Rotating Flange • Compatible with all Aquatherm® PP-R piping systems						
3/4"	25	91403WHV	1	20	27	
1"	32	91404WHV	1	20	43	
1 1/4"	40	91405WHV	1	20	52	
1 1/2"	50	91406WHV	1	10	35	
2"	63	91407WHV	1	10	42	
PP-RCT × Rotating Flange						
3/4"	25	101403WHV	1	20	28	
1"	32	101404WHV	1	20	39	
1 1/4"	40	101405WHV	1	20	52	
1 1/2"	50	101406WHV	1	10	35	
2"	63	101407WHV	1	10	42	

Also available for High Velocity Pumps – to order, add HV onto the end of the part #. • 2" Press & PP-R Available in High Velocity only, also fits standard size pumps. • 2" Isolators have 1 1/2" port.
 *Overall valve pressure rating at 73° F. Further restrictions determined by intended operating conditions and limitations specific to the system design. Maximum pressure rating for seat & body alone is 600 PSI.
 **Valve seat/body maximum pressure rating at 100° F. Overall valve pressure rating is determined by intended operating conditions and limitations specific to the system design.
 †PP-R & PP-RCT Sockets are manufactured based on metric units of measurement. Imperial nominal diameter is provided as reference only.



The Isolator® w/ Rotating Flange & Multi-Function Drain

Full Port Forged Brass Uni-Flange Ball Valve w/ Detachable Rotating Flange, Multi-Function Hi-Flow Hose Drain, Adjustable Packing Gland, Nuts & Bolts

600 WOG
ISO 9001



AVAILABLE W/
LEAD-FREE
CLEAN
BRASS

STANDARD BRASS

LEAD-FREE BRASS

Certified to NSF/ANSI 61-G

SIZE	ITEM #	P/CARTON	P/CASE	WT/CASE	ITEM #	P/CARTON	P/CASE	WT/CASE
IPS × Rotating Flange								
3/4"	41413	2	20	35	41413W	2	20	34
1"	41414	2	20	42	41414W	2	20	40
1 1/4"	41415	2	20	53	41415W	2	10	26
1 1/2"	41416	2	10	37	41416W	2	10	35
2"	-	-	-	-	41417WHV	1	10	37
SWT × Rotating Flange								
3/4"	51413	2	20	35	51413W	2	20	35
1"	51414	2	20	42	51414W	2	20	40
1 1/4"	51415	2	20	53	51415W	2	10	27
1 1/2"	51416	2	10	37	51416W	2	10	32
2"	-	-	-	-	51417WHV	1	10	35
Press × Rotating Flange								
3/4"	81413HV	1	20	36	-	-	-	-
1"	81414HV	1	20	42	-	-	-	-
1 1/4"	81415HV	1	10	29	-	-	-	-
1 1/2"	81416HV	1	10	37	-	-	-	-
2"	81417HV	1	10	39	-	-	-	-

250 CWP/250° F Max

AVAILABLE W/
LEAD-FREE
CLEAN
BRASS

Certified to NSF/ANSI 61 & NSF/ANSI 372

SIZE†	METRIC SIZE	ITEM #	P/CARTON	P/CASE	WT/CASE
PP-R × Rotating Flange • Compatible with all Aquatherm® PP-R piping systems					
3/4"	25	91413WHV	1	20	36
1"	32	91414WHV	1	20	44
1 1/4"	40	91415WHV	1	10	30
1 1/2"	50	91416WHV	1	10	39
2"	63	91417WHV	1	10	42
PP-RCT × Rotating Flange					
3/4"	25	101413WHV	1	20	36
1"	32	101414WHV	1	20	44
1 1/4"	40	101415WHV	1	10	30
1 1/2"	50	101416WHV	1	10	39
2"	63	101417WHV	1	10	42

Also available for High Velocity Pumps – to order, add HV onto the end of the part #. • 2" & Press Available in High Velocity only, also fits standard size pumps. • 2" Isolators have 1 1/2" port.
*Overall valve pressure rating at 73° F. Further restrictions determined by intended operating conditions and limitations specific to the system design. Maximum pressure rating for seat & body alone is 600 PSI.
**Valve seat/body maximum pressure rating at 100° F. Overall valve pressure rating is determined by intended operating conditions and limitations specific to the system design.
†PP-R & PP-RCT Sockets are manufactured based on metric units of measurement. Imperial nominal diameter is provided as reference only.



The Isolator® Circulator Pump Installation Kit

Your choice of Isolator® & Isolator® w/ Drain with 2 Full-Faced Flange Gaskets, Nuts & Bolts

600 WOG
ISO 9001



AVAILABLE W/
LEAD-FREE
CLEAN
BRASS

STANDARD BRASS

LEAD-FREE BRASS

Certified to NSF/ANSI 61-G

SIZE	ITEM #	P/CARTON	P/CASE	WT/CASE	ITEM #	P/CARTON	P/CASE	WT/CASE
THE ISOLATOR® CIRCULATOR PUMP INSTALLATION KIT								
IPS × Flange								
3/4"	40413KIT	1	10	36	-	-	-	-
1"	40414KIT	1	10	42	-	-	-	-
1 1/4"	40415KIT	1	10	51	-	-	-	-
SWT × Flange								
3/4"	50413KIT	1	10	36	-	-	-	-
1"	50414KIT	1	10	42	-	-	-	-
1 1/4"	50415KIT	1	10	53	-	-	-	-

Also available for High Velocity Pumps – to order, add HV onto the end of the part # before "KIT".

THE ISOLATOR® W/ ROTATING FLANGE CIRCULATOR PUMP INSTALLATION KIT

SIZE	ITEM #	P/CARTON	P/CASE	WT/CASE	ITEM #	P/CARTON	P/CASE	WT/CASE
IPS × Rotating Flange								
3/4"	41413KIT	1	10	31	41413WKIT	1	10	31
1"	41414KIT	1	10	38	41414WKIT	1	10	38
1 1/4"	41415KIT	1	10	49	41415WKIT	1	10	49
SWT × Rotating Flange								
3/4"	51413KIT	1	10	31	51413WKIT	1	10	31
1"	51414KIT	1	10	38	51414WKIT	1	10	38
1 1/4"	51415KIT	1	10	49	51415WKIT	1	10	49

Also available for High Velocity Pumps – to order, add HV onto the end of the part # before "KIT".



The Isolator® Select

Full Port Forged Brass Uni-Flange Ball Valve w/ 4-Way Selectable Flow Path Plugged FIP Ports, Adjustable Packing Gland, Nuts, Bolts, & Flange Gasket

250 CWP/250° F Max
ISO 9001



AVAILABLE W/
LEAD-FREE
CLEAN
BRASS

STANDARD BRASS

SIZE	ITEM #	P/CARTON	P/CASE	WT/CASE
Press × Rotating Flange				
1"	81424HV	1	10	34

Fits Standard & High Velocity Pumps



The Isolator® Double Flanged Check

Forged Brass Check Valve w/ Rotating Flange
Includes One Set of Mounting Bolts & Full Faced Flange Gasket

150 PSI @ 200° F
ISO 9001



SIZE	ITEM #	STANDARD BRASS		
		P/CARTON	P/CASE	WT/CASE
Flange x Rotating Flange				
3/4" thru 1 1/4"	13703HV	1	10	15
1 1/2" thru 2"	13706HV	1	10	17

Fits Standard & High Velocity Pumps



The Isolator® Double Flanged Check Replacement Components



COMPATIBILITY	ITEM #	P/CARTON	P/CASE	WT/CASE
REPLACEMENT INTEGRAL CHECK				
Fits 13703HV	C42404	1	1	.05
Fits 13706HV	C42406	1	1	.11
RETAINING RING				
Fits 13703HV	RR42404	1	1	.01
Fits 13706HV	RR42406	1	1	.01



The Isolator® w/ Round Flange

Full Port Forged Brass Uni-Flange Ball Valve
w/ Detachable Rotating Flange, Adjustable Packing Gland, Nuts & Bolts

600 WOG
ISO 9001



SIZE	ITEM #	STANDARD BRASS		
		P/CARTON	P/CASE	WT/CASE
WITH 3 3/4" DIAMETER ROUND FLANGE				
FIP x Rotating Flange				
1 1/2"	41406HV-RF375	1	6	25
SWT x Rotating Flange				
1 1/2"	51406HV-RF375	1	6	26
Press x Rotating Flange				
1 1/2"	81406HV-RF375	1	6	27
WITH 4" DIAMETER ROUND FLANGE				
FIP x Rotating Flange				
2"	41407HV-RF400	1	6	31
SWT x Rotating Flange				
2"	51407HV-RF400	1	6	33
Press x Rotating Flange				
2"	81407HV-RF400	1	6	33
WITH 4 3/4" DIAMETER ROUND FLANGE				
FIP x Rotating Flange				
2"	41407HV-RF475	1	6	32
SWT x Rotating Flange				
2"	51407HV-RF475	1	6	38
Press x Rotating Flange				
2"	81407HV-RF475	1	6	35



The Isolator® w/ Round Flange & Multi-Function Drain

Full Port Forged Brass Uni-Flange Ball Valve w/ Detachable Rotating Flange,
Multi-Function Hi-Flow Hose Drain, Adjustable Packing Gland, Nuts & Bolts

600 WOG
ISO 9001



SIZE	ITEM #	STANDARD BRASS		
		P/CARTON	P/CASE	WT/CASE
WITH 3 3/4" DIAMETER ROUND FLANGE				
FIP x Rotating Flange				
1 1/2"	41416HV-RF375	1	6	31
SWT x Rotating Flange				
1 1/2"	51416HV-RF375	1	6	31
Press x Rotating Flange				
1 1/2"	81416HV-RF375	1	6	31
WITH 4" DIAMETER ROUND FLANGE				
FIP x Rotating Flange				
2"	41417HV-RF400	1	6	31
SWT x Rotating Flange				
2"	51417HV-RF400	1	6	33
Press x Rotating Flange				
2"	81417HV-RF400	1	6	39
WITH 4 3/4" DIAMETER ROUND FLANGE				
FIP x Rotating Flange				
2"	41417HV-RF475	1	6	37
SWT x Rotating Flange				
2"	51417HV-RF475	1	6	39
Press x Rotating Flange				
2"	81417HV-RF475	1	6	40

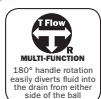

Webstone HELPS YOU WORK SMARTER

VALVE INNOVATION

WHY DO THIS?

WHEN YOU COULD DO THIS!



MATERIALS:

- 1 Ball Valve
- 1 Copper Nipple
- 1 Flange

LABOR:

- Cut 1 Short Copper Nipple
- Clean, Flux & Solder for 2 Joints



AVAILABLE W/
LEAD-FREE
CLEAN BRASS
THE LEAD CHOICE FOR THE PROFESSIONAL.

The ISOLATOR
UNI-FLANGE BALL VALVE®

W/ ROTATING FLANGE

- REPLACES 3 COMPONENTS
- ELIMINATES 2 LEAK PATHS
- SAVES 18 MINUTES OF LABOR

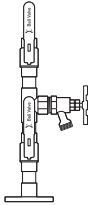

MATERIALS:

- 2 Ball Valves
- 1 Brass Tee
- 3 Copper Nipples
- 1 Boiler Drain
- 1 Flange

LABOR:

- Cut 3 Short Copper Nipples
- Clean, Flux & Solder for 6 Joints
- Seal and Thread in 1 Boiler Drain



AVAILABLE W/
LEAD-FREE
CLEAN BRASS
THE LEAD CHOICE FOR THE PROFESSIONAL.

The ISOLATOR
UNI-FLANGE BALL VALVE®

W/ ROTATING FLANGE & MULTI-FUNCTION DRAIN

- REPLACES 8 COMPONENTS
- ELIMINATES 7 LEAK PATHS
- SAVES 63 MINUTES OF LABOR

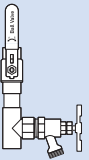

MATERIALS:

- 1 Ball Valve
- 1 Brass Tee
- 1 Copper Nipple
- 1 Boiler Drain

LABOR:

- Cut 1 Short Copper Nipple
- Clean, Flux & Solder for 2 Joints
- Seal and Thread in 1 Boiler Drain



AVAILABLE W/
LEAD-FREE
CLEAN BRASS
THE LEAD CHOICE FOR THE PROFESSIONAL.

PRO-PAL
SERIES

BALL DRAIN

- REPLACES 4 COMPONENTS
- ELIMINATES 3 LEAK PATHS
- SAVES 27 MINUTES OF LABOR

Drains from above or below the ball!

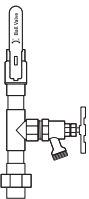

MATERIALS:

- 1 Ball Valve
- 1 Brass Tee
- 2 Copper Nipples
- 1 Boiler Drain
- 1 Union Fitting

LABOR:

- Cut 2 Short Copper Nipples
- Clean, Flux & Solder for 4 Joints
- Seal and Thread in 1 Boiler Drain



AVAILABLE W/
LEAD-FREE
CLEAN BRASS
THE LEAD CHOICE FOR THE PROFESSIONAL.

PRO-PAL
SERIES

UNION BALL DRAIN

- REPLACES 6 COMPONENTS
- ELIMINATES 5 LEAK PATHS
- SAVES 45 MINUTES OF LABOR

Drains from above or below the ball!

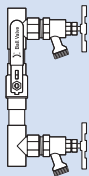

MATERIALS:

- 1 Ball Valve
- 2 Brass Tees
- 2 Copper Nipples
- 2 Boiler Drains

LABOR:

- Cut 2 Short Copper Nipples
- Clean, Flux & Solder for 4 Joints
- Seal and Thread in 2 Boiler Drains



AVAILABLE W/
LEAD-FREE
CLEAN BRASS
THE LEAD CHOICE FOR THE PROFESSIONAL.

PRO-PAL
SERIES

PURGE & FILL

- REPLACES 7 COMPONENTS
- ELIMINATES 6 LEAK PATHS
- SAVES 54 MINUTES OF LABOR



MATERIALS:

- 1 Ball Valve
- 2 Copper Tees
- 2 Copper Nipples

LABOR:

- Cut 2 Short Copper Nipples
- Clean, Flux & Solder for 4 Joints



AVAILABLE W/
LEAD-FREE
CLEAN BRASS
THE LEAD CHOICE FOR THE PROFESSIONAL.

PRO-PAL
SERIES

**PRIMARY/SECONDARY
PURGE TEE**

- REPLACES 5 COMPONENTS*
- ELIMINATES 4 LEAK PATHS
- SAVES 36 MINUTES OF LABOR

*Correct spacing for hydraulic separation cannot be achieved using off-the-shelf components. The Purge Tee™ is the ONLY way to place a valve between closely spaced tees.



MATERIALS:

- 1 Brass Tee
- 1 Boiler Drain

LABOR:

- Seal and Thread in 1 Boiler Drain



AVAILABLE W/
LEAD-FREE
CLEAN BRASS
THE LEAD CHOICE FOR THE PROFESSIONAL.

PRO-PAL
SERIES

T DRAIN

- REPLACES 2 COMPONENTS
- ELIMINATES 1 LEAK PATH
- SAVES 9 MINUTES OF LABOR

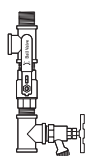

MATERIALS:

- 1 Ball Valve
- 2 Brass Tees
- 3 Threaded Nipples
- 1 Boiler Drain

LABOR:

- Seal and Thread in 6 Connections



AVAILABLE W/
LEAD-FREE
CLEAN BRASS
THE LEAD CHOICE FOR THE PROFESSIONAL.

PRO-PAL
SERIES

**EXPANSION TANK
PRO SERVICE VALVE**

- REPLACES 7 COMPONENTS
- ELIMINATES 6 LEAK PATHS
- SAVES 54 MINUTES OF LABOR

HYDRO-CORE™

A REVOLUTIONARY APPROACH TO HYDRONIC INSTALLATIONS

Combine a forged brass manifold and components to streamline boiler and secondary loop installations.

NEAR BOILER LOOPS: Numerous kits are available to provide solutions for these popular boiler styles:

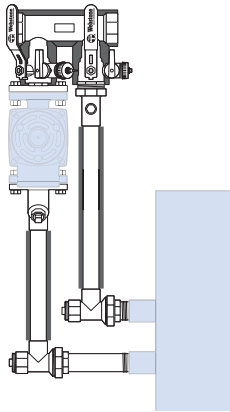

Floor Standing Side Mount Boilers

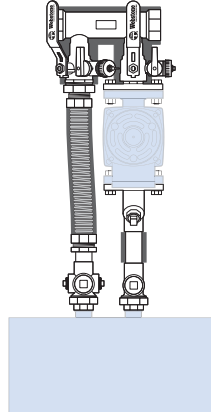

Floor Standing Top Mount Boilers

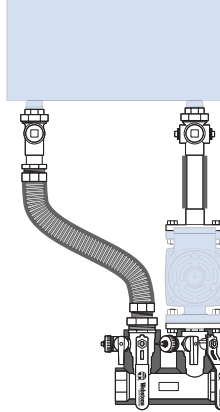

Wall Hung Boilers

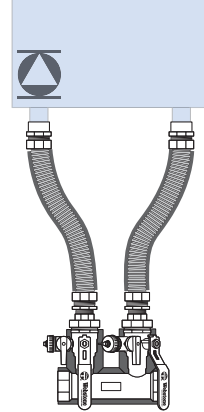

Wall Hung Boilers w/ Integral Pump

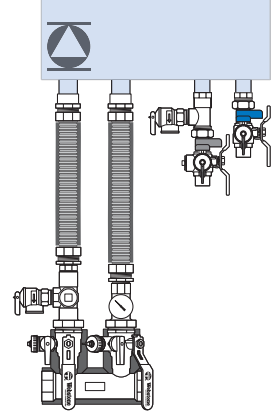

Combi Boilers

HYDRO-CORE™

COMPLETE NEAR BOILER PIPING KITS

SAVES LABOR, SPACE, AND LEAK PATHS

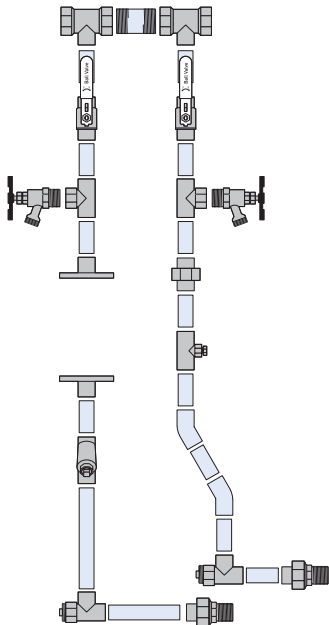

FIELD FABRICATED INSTALLATION

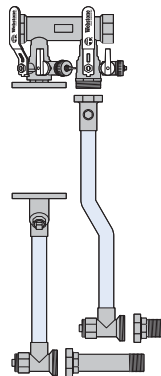

HYDRO-CORE™ COMPLETE NEAR BOILER PIPING KITS

COMPONENTS:

LEAK PATHS:

LABOR:

FIELD FABRICATED INSTALLATION

HYDRO-CORE™
COMPLETE NEAR BOILER PIPING KIT

	34	5
	32	3
	4 hours	27 minutes

COMPONENTS AND SAVINGS VARY BY KIT

VERSATILE SOLUTIONS

The Hydro-Core™ system offers varying degrees of simplicity and customization depending on your needs.

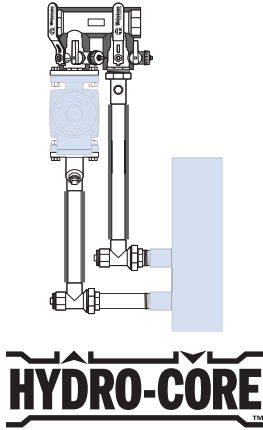
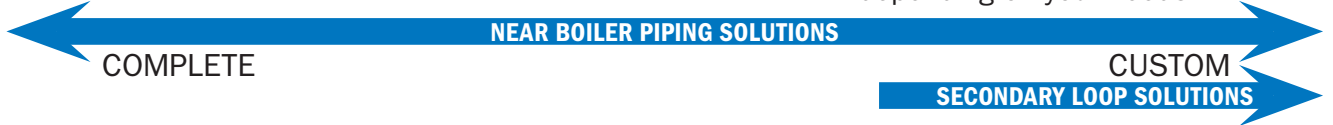

COMPLETE NEAR BOILER PIPING KITS

Everything but the pump! A complete solution for a wide array of boilers, includes the manifold, piping and all boiler connections.

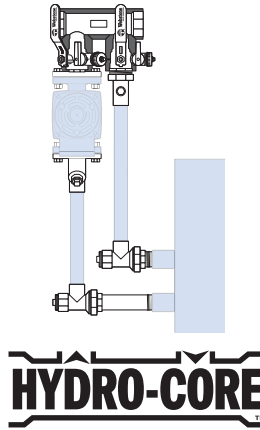

NEAR BOILER COMPONENT KITS

Pipe it yourself. Utilize Near Boiler Component kits including the manifold, pump connections, and boiler connections.

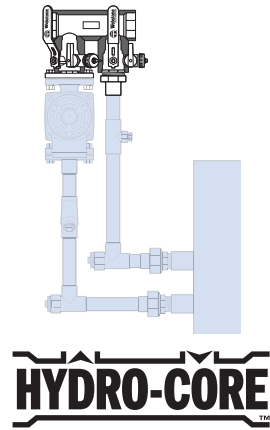

MANIFOLD + UNION CONNECTIONS

Utilize the manifold and basic union connection, but complete the rest of the work in the field.

FIND THE RIGHT KIT FOR YOUR BOILER AT WWW.WEBSTONEVALVES.COM/HYDROCORE

INSTALLATION KITS AVAILABLE TO FIT OVER 300 DIFFERENT BOILERS FROM:*

- BAXI
- BIAISI
- BOSCH
- BRADFORD WHITE
- BURNHAM
- CROWN BOILER
- DUNKIRK
- HEAT TRANSFER PRODUCTS
- IBC TECHNOLOGIES
- LAARS
- LOCHINVAR
- NAVIEN
- NEW YORK THERMAL NTI
- NORITZ
- PEERLESS
- PENSOTTI
- RAYPAK
- SIME
- SLANT FIN
- SMITH
- TRIANGLE TUBE
- UTICA
- VISSMANN
- WEIL-MCLAIN
- WILLIAMSON-THERMOFLO

* All manufacturer names, models and part numbers are trademarked or registered trademark property of their respective owners. Webstone products are not manufactured, sponsored, authorized, or endorsed by any party unless otherwise noted.

HYDRO-CORE Boiler Compatibility							Complete Piping Kit			
Manufacturer	Model	Number	Boiler Inlet/Outlet	Manifold Size	Run	MB Pp	FP Manifold	Free Manifold	FP Manifold	FP Manifold
Baxi	Luna 3	Comfort 1.31	3/4 SWT	1.5/4	1	1	4FK3-WSS	5FK3-WSS	6FK3-WSS	...
Baxi	Luna 3	Comfort 810	3/4 SWT	1.5/4	1	1	4FK3-WSS	5FK3-WSS	6FK3-WSS	...
Baxi	Luna Duo-Tec	1.33 GA	3/4 SWT	1.5/4	1	1	4FK3-WSS	5FK3-WSS	6FK3-WSS	...
Baxi	Luna Duo-Tec	40 GA	3/4 SWT	1.5/4	1	1	4FK3-WSS	5FK3-WSS	6FK3-WSS	...
Baxi	Luna HT	1.1	1 1/4 NPT	1.1/2	1	1.1/4	4CF3B-WH245	5CF3B-WH245	6CF3B-WH245	48765-WH245
Baxi	Luna HT	1.33	3/4 SWT	1.5/4	1	1	4FK3-WSS	5FK3-WSS	6FK3-WSS	...
Baxi	Luna HT	1.45	1 NPT	1.5/4	1	1	4CF4B-WH144	5CF4B-WH144	6CF4B-WH144	48754-WH144
Baxi	Luna HT	1.85	1 NPT	1.5/4	1	1	4CF4B-WH144	5CF4B-WH144	6CF4B-WH144	48754-WH144
Baxi	Luna HT	385	3/4 SWT	1.5/4	1	1	4FK3-WSS	5FK3-WSS	6FK3-WSS	...
Baxi	Riva	RI130.300R	3/4 SWT	1.5/4	1	1	4FK3-WSS	5FK3-WSS	6FK3-WSS	...
Baxi	Riva Advance Combo	M210.325	3/4 SWT	1.5/4	1	1	4FK3-WSS	5FK3-WSS	6FK3-WSS	...
Baxi	Riva Advance SV	M210.325SV	3/4 SWT	1.5/4	1	1	4FK3-WSS	5FK3-WSS	6FK3-WSS	...
Baxi	Riva Combo	M135.300C	3/4 SWT	1.5/4	1	1	4FK3-WSS	5FK3-WSS	6FK3-WSS	...
Baxi	Riva Plus Combo	M135.300C	3/4 SWT	1.5/4	1	1	4FK3-WSS	5FK3-WSS	6FK3-WSS	...
Baxi	Riva Plus Combo	M135.300C	3/4 SWT	1.5/4	1	1	4FK3-WSS	5FK3-WSS	6FK3-WSS	...
Baxi	Riva Plus Combo	M135.300C	3/4 SWT	1.5/4	1	1	4FK3-WSS	5FK3-WSS	6FK3-WSS	...
Brady	GreenStar 37	ZBR16.3	1 NPT	1.5/4	1	1	4FK4-WSS	5FK4-WSS	6FK4-WSS	...
Brady	GreenStar 79	ZBR21.3	1 NPT	1.5/4	1	1	4FK4-WSS	5FK4-WSS	6FK4-WSS	...
Brady	GreenStar 100	ZBR25.3	1 NPT	1.5/4	1	1	4FK4-WSS	5FK4-WSS	6FK4-WSS	...
Brady	GreenStar 131	ZBR31.3	1 NPT	1.5/4	1	1	4FK4-WSS	5FK4-WSS	6FK4-WSS	...
Brady	GreenStar 131	ZBR42.3	1 NPT	1.5/4	1	1	4FK4-WSS	5FK4-WSS	6FK4-WSS	...
Brady	GreenStar Combo 100	ZWB35.3	1 NPT	1.5/4	1	1	4FK4-WSS	5FK4-WSS	6FK4-WSS	...
Brady	GreenStar Combo 131	ZWB35.3	1 NPT	1.5/4	1	1	4FK4-WSS	5FK4-WSS	6FK4-WSS	...
Brady	GreenStar Combo 131	ZWB42.3	1 NPT	1.5/4	1	1	4FK4-WSS	5FK4-WSS	6FK4-WSS	...
Bradford White	White Deluxe	BMT2H.200	1 1/2 NPT	2	1	1.1/2
Bradford White	White Deluxe	BMT2H.300	1 1/2 NPT	2	1	1.1/2
Bradford White	White Deluxe	BMT2H.400	1 1/2 NPT	2	1	1.1/2
Bradford White	White Elite	BNT4-080	1 NPT	1.5/4	1	1	4CF4B-F1144	5CF4B-F1144	6CF4B-F1144	48754-F1144
Bradford White	White Elite	BNT4-105	1 NPT	1.5/4	1	1	4CF4B-F1144	5CF4B-F1144	6CF4B-F1144	48754-F1144
Bradford White	White Elite	BNT4-130	1 NPT	1.5/4	1	1	4CF4B-F1144	5CF4B-F1144	6CF4B-F1144	48754-F1144
Bradford White	White Elite	BNT4-210	1 NPT	1.5/4	1	1	4CF4B-F1144	5CF4B-F1144	6CF4B-F1144	48754-F1144
Bradford White	White Elite	BNT4-285	1 1/4 NPT	1.1/2	1	1.1/4	4CF3-F1245	5CF3-F1245	6CF3-F1245	48765-F1245
Bradford White	White Elite	BNT4-339	1 1/4 NPT	1.1/2	1	1.1/4	4CF3-F1245	5CF3-F1245	6CF3-F1245	48765-F1245
Bradford White	White Elite	BNT4-500	1 1/2 NPT	2	1	1.1/2
Bradford White	White Elite	BNT4-600	1 1/2 NPT	2	1	1.1/2
Bradford White	White Elite 125	BLM4-125NA	3/4 SWT	1.5/4	1	1	4FK3-WSS-18	5FK3-WSS-18	6FK3-WSS-18	...
Bradford White	White Elite 125 Combo	BLM4-125NA	3/4 SWT	1.5/4	1	1	4FK3-WSS-18	5FK3-WSS-18	6FK3-WSS-18	...
Bradford White	White Mini	BVS-050	1 1/4 NPT	1.1/2	1	1.1/4	4CF3-F1245	5CF3-F1245	6CF3-F1245	48765-F1245
Bradford White	White Mini	BVS-075	1 1/4 NPT	1.1/2	1	1.1/4	4CF3-F1245	5CF3-F1245	6CF3-F1245	48765-F1245
Bradford White	White Mini	BVS-100	1 1/4 NPT	1.1/2	1	1.1/4	4CF3-F1245	5CF3-F1245	6CF3-F1245	48765-F1245
Bradford White	White Mini	BVS-125	1 1/4 NPT	1.1/2	1	1.1/4	4CF3-F1245	5CF3-F1245	6CF3-F1245	48765-F1245
Bradford White	White Mini	BVS-150	1 1/4 NPT	1.1/2	1	1.1/4	4CF3-F1245	5CF3-F1245	6CF3-F1245	48765-F1245
Bradford White	White Mini	BVS-175	1 1/4 NPT	1.1/2	1	1.1/4	4CF3-F1245	5CF3-F1245	6CF3-F1245	48765-F1245
Bradford White	White Mini	BVS-225	1 1/4 NPT	1.1/2	1	1.1/4	4CF3-F1245	5CF3-F1245	6CF3-F1245	48765-F1245

SOLUTIONS FOR SECONDARY CIRCUIT LOOPS

The Hydro-Core™ Manifold w/ Union Connection can be used anywhere a secondary circuit loop is required in a hydronic system.

SEE WWW.WEBSTONEVALVES.COM/HYDROCORE FOR A FULL BOILER COMPATIBILITY CHART

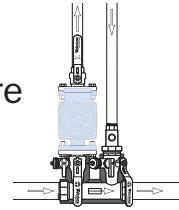

**HYDRO-CORE
MANIFOLD**

Forged Brass Hydronic Valve Manifold w/ Union Connection

Closely Spaced Tees w/ (2) Full Port Isolation Valves, Hi-Flow Hose Drains & Adjustable Packing Glands
For near boiler and secondary circuit loop applications

**600 WOG
ISO 9001**

STANDARD BRASS

RUN SIZE SECONDARY LOOP CONNECTION ITEM # P/CARTON P/CASE WT/CASE

FLANGE RIGHT

Press System Piping

1 1/4"	3/4" FIP	88754-43	1	6	44
1 1/4"	1" FIP	88754-44	1	6	43
1 1/4"	3/4" SWT	88754-53	1	6	48
1 1/4"	1" SWT	88754-54	1	6	58
1 1/4"	1 1/4" FIP	88755-45	1	6	66
1 1/4"	1 1/4" SWT	88755-55	1	6	62
1 1/2"	1" FIP	88764-44	1	6	53
1 1/2"	1" SWT	88764-54	1	6	55
1 1/2"	1 1/4" FIP	88765-45	1	6	65
1 1/2"	1 1/4" SWT	88765-55	1	6	64
1 1/2"	1 1/2" SWT	88766-56	1	6	75

IPS System Piping

1 1/4"	3/4" FIP	48754-43	1	6	38
1 1/4"	1" FIP	48754-44	1	6	37
1 1/4"	1 1/4" FIP	48755-45	1	6	59
1 1/2"	1" FIP	48764-44	1	6	46
1 1/2"	1 1/4" FIP	48765-45	1	6	57
1 1/2"	1 1/2" SWT	48766-56	1	4	45

SWT System Piping

1"	3/4" SWT	58744-53	1	6	42
1"	1" SWT	58744-54	1	6	42
1 1/4"	3/4" SWT	58754-53	1	6	42
1 1/4"	1" SWT	58754-54	1	6	52
1 1/4"	1 1/4" SWT	58755-55	1	6	55
1 1/2"	1" SWT	58764-54	1	6	47
1 1/2"	1 1/4" SWT	58765-55	1	6	56
1 1/2"	1 1/2" SWT	58766-56	1	4	45
2"	1" FIP	58774-44	1	4	32
2"	1 1/4" FIP	58775-45	1	4	41
2"	1 1/2" SWT	58776-56	1	4	48

FLANGE LEFT

Press System Piping

1 1/4"	3/4" FIP	88854-43	1	6	44
1 1/4"	1" FIP	88854-44	1	6	45
1 1/4"	3/4" SWT	88854-53	1	6	44
1 1/4"	1" SWT	88854-54	1	6	52
1 1/4"	1 1/4" SWT	88855-55	1	6	62
1 1/2"	1" FIP	88864-44	1	6	53
1 1/2"	1" SWT	88864-54	1	6	55
1 1/2"	1 1/4" FIP	88865-45	1	6	65
1 1/2"	1 1/4" SWT	88865-55	1	6	61

IPS System Piping

1 1/4"	3/4" FIP	48854-43	1	6	39
1 1/4"	1" FIP	48854-44	1	6	39
1 1/4"	1 1/4" FIP	48855-45	1	6	59
1 1/2"	1" FIP	48864-44	1	6	46
1 1/2"	1 1/4" FIP	48865-45	1	6	57

SWT System Piping

1 1/4"	3/4" SWT	58854-53	1	6	42
1 1/4"	1" SWT	58854-54	1	6	46
1 1/4"	1 1/4" SWT	58855-55	1	6	56
1 1/2"	1" SWT	58864-54	1	6	47
1 1/2"	1 1/4" SWT	58865-55	1	6	53

DOUBLE BALL DRAIN

Press System Piping

1 1/4"	3/4" FIP	88354-43	1	6	45
1 1/4"	1" FIP	88354-44	1	6	41
1 1/4"	3/4" SWT	88354-53	1	6	42
1 1/4"	1" SWT	88354-54	1	6	42

IPS System Piping

1 1/4"	3/4" FIP	48354-43	1	6	38
1 1/4"	1" FIP	48354-44	1	6	34

SWT System Piping

1 1/4"	3/4" FIP	58354-43	1	6	37
1 1/4"	3/4" SWT	58354-53	1	6	36
1 1/4"	1" SWT	58354-54	1	6	36

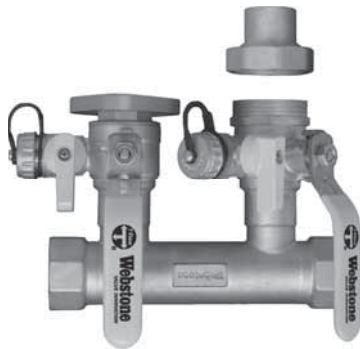

CUSTOMIZE YOUR HYDRO-CORE™ INSTALLATION

Have an unusual set of system requirements or a particularly unique area to work within?
 Craft your own kit - all Hydro-Core™ components are available for individual purchase.

SEE WWW.WEBSTONEVALVES.COM/HYDROCORE FOR A FULL SELECTION OF PARTS & ACCESSORIES



Union Connection

Hydro-Core Manifold required for installation - match Union Connection size for compatibility

ISO 9001



STANDARD BRASS					
SECONDARY LOOP SIZE	UNION CONNECTION SIZE	ITEM #	P/CARTON	P/CASE	WT/CASE
UNION CONNECTION					
IPS Secondary Loop Piping					
3/4"	1"	HCE4-43	6	24	13
1"	1"	HCE4-44	6	24	10
1"	1 1/4"	HCE5-44	6	24	20
1 1/4"	1 1/4"	HCE5-45	6	24	15
SWT Secondary Loop Piping					
3/4"	1"	HCE4-53	6	24	11
1"	1"	HCE4-54	6	24	11
1"	1 1/4"	HCE5-54	6	24	16
1 1/4"	1 1/4"	HCE5-55	6	24	17
1 1/2"	1 1/2"	HCE6-56	4	24	22

STANDARD BRASS					
SECONDARY LOOP SIZE	UNION CONNECTION SIZE	ITEM #	P/CARTON	P/CASE	WT/CASE
UNION CONNECTION W/ 1/4" NPT GAUGE PORT (PLUGGED)					
IPS Secondary Loop Piping					
3/4"	1"	HCE4-63	6	24	24
1"	1"	HCE4-64	6	24	21
1"	1 1/4"	HCE5-64	6	24	36
1 1/4"	1 1/4"	HCE5-65	6	24	37
SWT Secondary Loop Piping					
3/4"	1"	HCE4-73	6	24	18
1"	1"	HCE4-74	6	24	18
1"	1 1/4"	HCE5-74	6	24	26
1 1/4"	1 1/4"	HCE5-75	6	24	26

STANDARD BRASS					
SECONDARY LOOP SIZE	UNION CONNECTION SIZE	ITEM #	P/CARTON	P/CASE	WT/CASE
UNION CONNECTION W/ MULTIPLE DEVICE PORTS					
PLUGGED CONNECTIONS FOR (2) 3/4" DEVICES OR (1) 3/4" DEVICE & (1) 1/4" PRESSURE GAUGE					
SWT Secondary Loop Piping					
1"	1"	HCE4-94	6	24	26

SIZE	ITEM #	P/CARTON	P/CASE	WT/CASE
STAINLESS STEEL LIQUID FILLED DUAL SCALE PRESSURE GAUGE				
2" DIAL W/ CENTER BACK CONNECTION				
1/4 NPT	31000	1	100	37



Pump Connection

ISO 9001



STANDARD BRASS				
SIZE	ITEM #	P/CARTON	P/CASE	WT/CASE
ROTATING FLANGE				
SWT Secondary Loop Piping				
1"	RF4-54	6	24	24
1 1/4"	RF5-55	6	24	22

STANDARD BRASS				
SIZE	ITEM #	P/CARTON	P/CASE	WT/CASE
ROTATING FLANGE W/ "Y" STRAINER				
SWT Secondary Loop Piping				
1"	FSTR4-54	6	24	38
1 1/4"	FSTR5-55	6	24	46

Forged Brass Air Separator

w/ Removable Vent Head & Coalescing Medium

150 PSI
ISO 9001



SIZE	STANDARD BRASS			
	ITEM #	P/CARTON	P/CASE	WT/CASE
IPS				
3/4"	74003	1	10	27
1"	74004	1	10	26
1 1/4"	74005	1	10	26
1 1/2"	74006	1	10	62
2"	74007	1	10	66
SWT				
3/4"	75003	1	10	24
1"	75004	1	10	24
1 1/4"	75005	1	10	24
1 1/2"	75006	1	10	64
2"	75007	1	10	64
Press				
3/4"	78003	1	10	29
1"	78004	1	10	31
1 1/4"	78005	1	10	35
1 1/2"	78006	1	10	75
2"	78007	1	10	84

Replacement Vent Assembly

ISO 9001



SIZE	ITEM #	P/CARTON	P/CASE	WT/CASE
FITS 3/4"-2" AIR SEPARATOR	74000	1	50	12

Forged Brass Thermostatic Mixing Valve

w/ Temperature Locking Handle • For Point of Use, Hydronic Heat, and Water Distribution Systems • Lead-Free

150 PSI
ISO 9001



SIZE	OUTLET TEMPERATURE RANGE 95-131° F				OUTLET TEMPERATURE RANGE 95-120° F			
	ITEM #	P/CARTON	P/CASE	WT/CASE	ITEM #	P/CARTON	P/CASE	WT/CASE
ASTM F1807 PEX								
1/2"	73102W	1	10	17	73102W-CAN	1	10	14
3/4"	73103W	1	10	18	73103W-CAN	1	10	14
Press								
1/2"	78102W	1	10	18	78102W-CAN	1	10	18
3/4"	78103W	1	10	20	78103W-CAN	1	10	20
1"	78104W	1	10	21	78104W-CAN	1	10	20
MIP								
1/2"	74102W	1	10	18	74102W-CAN	1	10	18
3/4"	74103W	1	10	18	74103W-CAN	1	10	18
1"	74104W	1	10	21	74104W-CAN	1	10	21
SWT								
1/2"	75102W	1	10	18	75102W-CAN	1	10	18
3/4"	75103W	1	10	18	75103W-CAN	1	10	18
1"	75104W	1	10	21	75104W-CAN	1	10	19



OUTLET TEMPERATURE RANGE 95-131° F

OUTLET TEMPERATURE RANGE 95-120° F



OUTLET TEMPERATURE RANGE 95-131° F

OUTLET TEMPERATURE RANGE 95-120° F

Certified to ASSE 1017, CSA B125.3, & NSF/ANSI 372

Forged Brass Thermostatic Mixing Valve w/ Integral Check Valve

w/ Temperature Locking Handle • For Point of Use, Hydronic Heat, and Water Distribution Systems • Lead-Free

150 PSI
ISO 9001



SIZE	OUTLET TEMPERATURE RANGE 95-131° F				OUTLET TEMPERATURE RANGE 95-120° F			
	ITEM #	P/CARTON	P/CASE	WT/CASE	ITEM #	P/CARTON	P/CASE	WT/CASE
ASTM F1807 PEX								
1/2"	73202W	1	10	17	73202W-CAN	1	10	14
3/4"	73203W	1	10	17	73203W-CAN	1	10	14
Press								
1/2"	78202W	1	10	19	78202W-CAN	1	10	18
3/4"	78203W	1	10	20	78203W-CAN	1	10	20
1"	78204W	1	10	21	78204W-CAN	1	10	21
MIP								
1/2"	74202W	1	10	18	74202W-CAN	1	10	18
3/4"	74203W	1	10	18	74203W-CAN	1	10	18
1"	74204W	1	10	22	74204W-CAN	1	10	21
Compression								
3/8"	74401W	1	10	16	-	-	-	-
SWT								
1/2"	75202W	1	10	16	75202W-CAN	1	10	18
3/4"	75203W	1	10	18	75203W-CAN	1	10	18
1"	75204W	1	10	21	75204W-CAN	1	10	19



OUTLET TEMPERATURE RANGE 95-131° F

OUTLET TEMPERATURE RANGE 95-120° F



OUTLET TEMPERATURE RANGE 95-131° F

OUTLET TEMPERATURE RANGE 95-120° F

Certified to ASSE 1070, ASSE 1017, CSA B125.3, & NSF/ANSI 372

ASSE 1070 does not apply to 74401W

Stainless Steel Liquid Filled Dual Scale Pressure Gauge

2" Dial w/ Center Back Connection

30 PSI
ISO 9001



SIZE	ITEM #	P/CARTON	P/CASE	WT/CASE
1/4" NPT	31000	1	100	37

Add-a-Gauge Tool

Forged Brass Hose Fitting

250 PSI MAX
ISO 9001



LEAD-FREE BRASS

SIZE	ITEM #	P/CARTON	P/CASE	WT/CASE
w/ 1/8" Bleeder (Capped) & 1/4" NPT Connection for Pressure Gauge				
3/4" Hose Drain Union x 1/4" NPT	30000W-P	10	100	30
w/ 1/8" Bleeder (Capped) & 1/2" NPT Connection for Temperature and/or Pressure Gauge				
3/4" Hose Drain Union x 1/2" NPT	30000W-TP	10	100	26

WHERE WOULD YOU USE WEBSTONE?

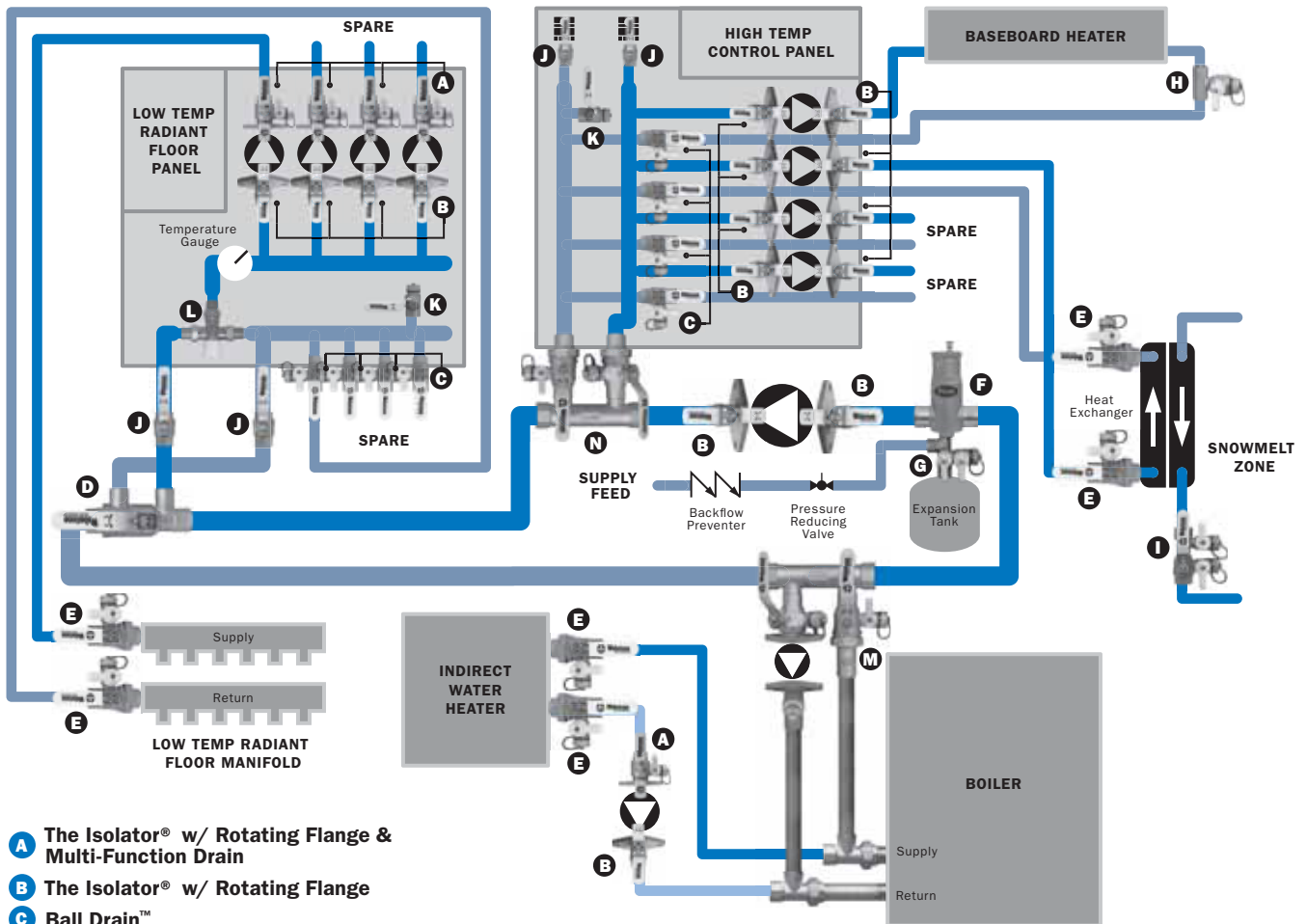

- A** The Isolator® w/ Rotating Flange & Multi-Function Drain
- B** The Isolator® w/ Rotating Flange
- C** Ball Drain™
- D** Purge Tee™
- E** Union Ball Drain™
- F** Forged Brass Air Separator
- G** Expansion Tank Pro Service Valve™
- H** T-Drain
- I** Purge & Fill™
- J** 4170/5170/8170 Series Full Port Forged Brass Ball Valve
- K** 4031/5031 Series Full Port Forged Brass Ball Valve w/ Hose End
- L** Thermostatic Mixing Valve
- M** Hydro-Core Complete Near Boiler Piping Kit
- N** Hydro-Core Double Ball Drain Manifold

ADVANTAGES TO COMPLETE INSTALLATION

- Total Leak Paths Avoided: ~180
- Total Labor Savings: ~27 hours

Brass Radiator Gate Valve

w/ Ground Joint Union Nut & Tailpiece

125 PSI/15 WSP
ISO 9001



SIZE IPS	STANDARD BRASS			
	ITEM #	P/CARTON	P/CASE	WT/CASE
3/4"	11523	6	60	72
1"	11524	4	36	66
1 1/4"	11525	2	24	59
1 1/2"	11526	2	16	59

Brass Steam Radiator Globe Valve

Angled w/ Ground Joint Union Nut & Tailpiece

60 PSI/15 WSP
ISO 9001



SIZE IPS	STANDARD BRASS			
	ITEM #	P/CARTON	P/CASE	WT/CASE
3/4"	11533	6	48	54
1"	11534	4	36	53
1 1/4"	11535	2	24	50
1 1/2"	11536	2	16	48

Brass Hot Water Radiator Globe Valve

Angled w/ Ground Joint Union Nut & Tailpiece

60 PSI
ISO 9001



SIZE IPS	STANDARD BRASS			
	ITEM #	P/CARTON	P/CASE	WT/CASE
3/4"	11553	6	60	50
1"	11554	4	36	48
1 1/4"	11555	2	24	50
1 1/2"	11556	2	16	39

Brass Union Elbow & Nut for Radiator Valve

Ground Joint Union Connection

60 PSI/15 WSP
ISO 9001



SIZE FIP x MIP	STANDARD BRASS			
	ITEM #	P/CARTON	P/CASE	WT/CASE
3/4"	11533-E	10	100	56
1"	11534-E	7	70	64
1 1/4"	11535-E	5	50	72

Brass Union Tailpiece & Nut for Radiator Valve

Ground Joint Nut & Tailpiece

60 PSI/15 WSP
ISO 9001



SIZE FIP x MIP	STANDARD BRASS			
	ITEM #	P/CARTON	P/CASE	WT/CASE
3/4"	11533-T	22	220	68
1"	11534-T	16	160	70
1 1/4"	11535-T	10	100	66

Brass Balancing Valve

w/ Butterfly Action & Screwdriver Slot

125 PSI
ISO 9001



SIZE SWT	STANDARD BRASS			
	ITEM #	P/CARTON	P/CASE	WT/CASE
3/4"	20103	12	72	32

Brass Purge & Balancing Valve

w/ Butterfly Action & Screwdriver Slot

125 PSI
ISO 9001



SIZE SWT x SWT x Hose	STANDARD BRASS			
	ITEM #	P/CARTON	P/CASE	WT/CASE
3/4"	11603	12	72	42

Brass Steam Radiator Air Vent Valve

Chrome Plated Float Type — Non Vacuum

10 PSI
ISO 9001



SIZE	STANDARD BRASS			
	ITEM #	P/CARTON	P/CASE	WT/CASE
Angle				
1/8"	11511	12	72	9
Straight				
1/8"	11512	12	72	8
1/4"	11513	12	72	12
Adjustable Angle				
1/8"	11515-A	12	72	9

Forged Brass Auto Steam Vent Valve

Stainless Steel Check Ball & Spring

125 PSI
ISO 9001



SIZE IPS	STANDARD BRASS			
	ITEM #	P/CARTON	P/CASE	WT/CASE
1/8"	11516	50	500	30
1/4"	11517	50	500	66

Brass Tank Valve (Globe)

Hard Seat

125 PSI
ISO 9001



SIZE MIP	STANDARD BRASS			
	ITEM #	P/CARTON	P/CASE	WT/CASE
1/2" x 3/8"	11401	6	72	57
MIP x Flare 1/2" x 3/8"	11403	6	72	62

Radiator Valve Spud Wrench



SIZE	ITEM #	P/CARTON	P/CASE	WT/CASE
1/2" to 2"	25011	10	20	48

BOILER DRAINS

Brass Boiler Drain

200 PSI
ISO 9001



SIZE MIP x Hose	LEAD-FREE BRASS			
	ITEM #	P/CARTON	P/CASE	WT/CASE
1/2"	11702W	12	72	27
3/4"	11703W	12	72	30

Brass Boiler Drain w/ Stuffing Box

200 PSI
ISO 9001



SIZE	STANDARD BRASS				LEAD-FREE BRASS			
	ITEM #	P/CARTON	P/CASE	WT/CASE	ITEM #	P/CARTON	P/CASE	WT/CASE
MIP x Hose (Hi-Flow)								
1/2"	-	-	-	-	11700W	12	72	35
3/4"	-	-	-	-	11701W	12	72	37
MIP x Hose								
1/2"	-	-	-	-	11704W	12	72	32
3/4"	-	-	-	-	11705W	12	72	32
FIP x Hose								
1/2"	11709	12	72	34	-	-	-	-
3/4"	11712	12	72	35	-	-	-	-

Brass Water Heater Drain Valve

125 PSI
ISO 9001



SIZE Hose	LEAD-FREE BRASS			
	ITEM #	P/CARTON	P/CASE	WT/CASE
3/4"	11710W	12	72	41

Brass Water Heater Drain Valve w/ Recirculating Elbow (Tan Handle)

125 PSI
ISO 9001



SIZE Hose	LEAD-FREE BRASS			
	ITEM #	P/CARTON	P/CASE	WT/CASE
3/4"	11711W	12	72	46



The Isolator® E-X-P™

Tankless Water Heater Service Valve Kit · Hot & Cold Set of Full Port Forged Brass Ball Valves w/ Hi-Flow Hose Drains, Pressure Relief Valve Outlet & Adjustable Packing Glands

**600 WOG
ISO 9001**

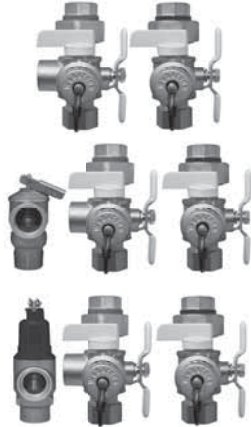

LEAD-FREE BRASS

Certified to NSF/ANSI 61-G & 372

SIZE	ITEM #	P/CARTON	P/CASE	WT/CASE
INCLUDES RESIDENTIAL PRESSURE RELIEF VALVE (150 PSI/200,000 BTU)				
IPS Union x IPS				
3/4"	40443W	1	8	39
IPS Union x SWT				
3/4"	50443W	1	8	37
INCLUDES RESIDENTIAL PRESSURE RELIEF VALVE (150 PSI/200,000 BTU)				
IPS Union x IPS				
3/4"	40443WPR	1	8	50
IPS Union x SWT				
3/4"	50443WPR	1	8	50
INCLUDES COMMERCIAL GRADE PRESSURE RELIEF VALVE (150 PSI/2.7M BTU) & CLOSE NIPPLE				
IPS Union x IPS				
3/4"	40443WPR2	1	8	50
IPS Union x SWT				
3/4"	50443WPR2	1	8	50



The Isolator® E-X-P™ E2

Tankless Water Heater Service Valve Kit · Hot & Cold Set of Full Port Forged Brass Ball Valves w/ Hi-Flow Hose Drains, Pressure Relief Valve Outlet & Adjustable Packing Glands

**500 WOG
ISO 9001**



LEAD-FREE BRASS

Certified to NSF/ANSI 61-G & 372

SIZE	ITEM #	P/CARTON	P/CASE	WT/CASE
INCLUDES RESIDENTIAL PRESSURE RELIEF VALVE (150 PSI/200,000 BTU)				
IPS Union x IPS				
3/4"	44443WPR	1	10	36
1"	44444WPR	1	10	64
IPS Union x SWT				
3/4"	54443WPR	1	10	41
1"	54444WPR	1	10	64
IPS Union x Press				
3/4"	84443WPR	1	10	35
1"	84444WPR	1	10	64
INCLUDES LEAD-FREE RESIDENTIAL PRESSURE RELIEF VALVE (150 PSI/200,000 BTU)				
IPS Union x PS				
3/4"	44443WPR-LF	1	10	36
1"	44444WPR-LF	1	10	64
IPS Union x SWT				
3/4"	54443WPR-LF	1	10	41
1"	54444WPR-LF	1	10	64
IPS Union x Press				
3/4"	84443WPR-LF	1	10	35
1"	84444WPR-LF	1	10	64
INCLUDES COMMERCIAL GRADE PRESSURE RELIEF VALVE (150 PSI/2.7M BTU) & CLOSE NIPPLE				
IPS Union x IPS				
3/4"	44443WPR2	1	10	44
1"	44444WPR2	1	10	72
IPS Union x SWT				
3/4"	54443WPR2	1	10	49
1"	54444WPR2	1	10	72
IPS Union x Press				
3/4"	84443WPR2	1	10	44
1"	84444WPR2	1	10	73



The Isolator® E-X-P™ E3

Tankless Water Heater Service Valve Kit · Hot & Cold Set of Full Port Forged Brass Ball Valves w/ Hi-Flow Hose Drains, Adjustable Pressure Relief Valve Outlet & Adjustable Packing Glands

**500 WOG
ISO 9001**



LEAD-FREE BRASS

Certified to NSF/ANSI 61-G & 372

SIZE	ITEM #	P/CARTON	P/CASE	WT/CASE
INCLUDES RESIDENTIAL PRESSURE RELIEF VALVE (150 PSI/200,000 BTU)				
IPS Union x IPS				
3/4"	45443WPR	1	10	47
IPS Union x SWT				
3/4"	55443WPR	1	10	44
INCLUDES COMMERCIAL GRADE PRESSURE RELIEF VALVE (150 PSI/2.7M BTU) & CLOSE NIPPLE				
IPS Union x IPS				
3/4"	45443WPR2	1	10	55
IPS Union x SWT				
3/4"	55443WPR2	1	10	52



The Isolator® E-X-P™ Complete Tankless Water Heater Service Valve Kit

ISO 9001

Includes E-X-P™/E2/E3 Service Valves w/ Residential Pressure Relief Valve (150 PSI/200,000 BTU) 3/4 CGA Gas Ball Valve (175 WOG), & 24" x 3/4" Gas Flex Line

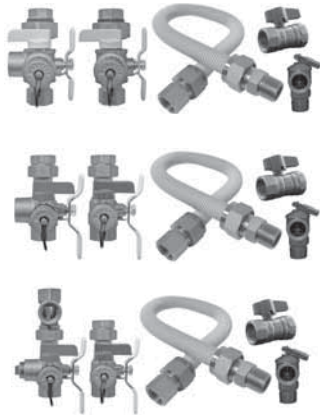

LEAD-FREE BRASS

Certified to NSF/ANSI 61-G & 372

SIZE	ITEM #	P/CARTON	P/CASE	WT/CASE
THE ISOLATOR® E-X-P™				
IPS Union x IPS				
3/4"	40443WCOM	1	4	38
IPS Union x SWT				
3/4"	50443WCOM	1	4	38
THE ISOLATOR® E-X-P™ E2				
IPS Union x IPS				
3/4"	44443WCOM	1	4	28
IPS Union x SWT				
3/4"	54443WCOM	1	4	29
THE ISOLATOR® E-X-P™ E3				
IPS Union x IPS				
3/4"	45443WCOM	1	4	32
IPS Union x SWT				
3/4"	55443WCOM	1	4	31



Wall Hung & Combi Boiler Service Valve Kits

500 WOG

ISO 9001

Hot & Cold Set of Full Port Forged Brass Ball Valves w/ Hi-Flow Hose Drains, Pressure Relief Valve Outlet & Adjustable Packing Glands • Includes Residential Pressure Relief Valve (30 PSI/510,000 BTU)



STANDARD BRASS

LEAD-FREE BRASS

Certified to NSF/ANSI 61-G & 372

SIZE	ITEM #	P/CARTON	P/CASE	WT/CASE	ITEM #	P/CARTON	P/CASE	WT/CASE
IPS Union x IPS								
3/4"	-	-	-	-	44443WPR3	1	10	36
1"	44444PR3	1	10	64	44444WPR3	1	10	64
IPS Union x SWT								
3/4"	-	-	-	-	54443WPR3	1	10	41
1"	54444PR3	1	10	64	54444WPR3	1	10	64
IPS Union x Press								
3/4"	-	-	-	-	84443WPR3	1	10	35
1"	-	-	-	-	84444WPR3	1	10	64
INCLUDES ADJUSTABLE PRESSURE RELIEF VALVE OUTLET								
IPS Union x IPS								
3/4"	-	-	-	-	45443WPR3	1	10	47
IPS Union x SWT								
3/4"	-	-	-	-	55443WPR3	1	10	44

PAIR W/ E-X-P™ TWH KITS FOR COMBI BOILER DOMESTIC HOT WATER CONNECTIONS

THE ISOLATOR® E-X-P™ ACCESSORIES

The Isolator® E-X-P™ Pressure Relief Valve Relocation Adapter

ISO 9001

Relocates Direction of Pressure Relief Valve in Recessed Boxes, Tight or Unique Installations



STANDARD BRASS

LEAD-FREE BRASS

Certified to NSF/ANSI 61-G

SIZE	ITEM #	P/CARTON	P/CASE	WT/CASE	ITEM #	P/CARTON	P/CASE	WT/CASE
Fits E-X-P™								
3/4"	28003	1	100	85	-	-	-	-
Fits E-X-P™ E2								
3/4"	-	-	-	-	28023W	10	100	57

Pressure Relief Valves

ISO 9001



STANDARD BRASS

LEAD-FREE BRASS

SIZE	ITEM #	P/CARTON	P/CASE	WT/CASE	ITEM #	P/CARTON	P/CASE	WT/CASE
RESIDENTIAL PRESSURE RELIEF VALVE								
AB 1953(CA) S.152 (VT), 372 (MD)								
150 PSI/200,000 BTU								
3/4"	20713	1	100	45	20713W	1	100	45
30 PSI/510,000 BTU								
3/4"	20733	1	100	45	-	-	-	-
COMMERCIAL PRESSURE RELIEF VALVE (REQUIRES CLOSE NIPPLE # 29003)								
150 PSI/2.7M BTU								
3/4"	20723	1	24	30	-	-	-	-
Close Nipple								
3/4"	29003	1	100	11	29003W	1	100	10

Certifications do not apply to 29003

Certifications do not apply to 29003W



Pro-Connect ProPush™ Coupling
 Forged Dezincification Resistant Brass Fitting
 For Connection to Copper, CPVC or PEX • Lead-Free

200 PSI/200° F
ISO 9001



INDIVIDUALLY PACKED

Certified to ASSE 1061 & NSF/ANSI 61-G

BULK PACKED

Certified to ASSE 1061 & NSF/ANSI 61-G

SIZE **ITEM #** **P/CARTON** **P/CASE** **WT/CASE** **ITEM #** **P/CARTON** **P/CASE** **WT/CASE**

STRAIGHT COUPLING

Push

1/4"	-	-	-	-	26100W-B	6	600	32
1/4" x 1/2"	-	-	-	-	26120W-B	6	150	14
3/8"	26101W	25	250	23	26101W-B	6	360	31
3/8" x 1/2"	26112W	25	250	28	26112W-B	6	150	17
1/2"	26102W	25	250	30	26102W-B	12	240	30
3/4"	26103W	10	100	20	26103W-B	12	180	34
3/4" x 1/2"	26132W	15	150	26	26132W-B	12	120	20
1"	26104W	9	90	28	26104W-B	6	90	28
1" x 3/4"	26143W	9	90	23	26143W-B	6	90	23
1 1/4"	-	-	-	-	26105W-B	1	30	35
1 1/4" x 1"	-	-	-	-	26154W-B	1	30	24
1 1/2"	-	-	-	-	26106W-B	1	27	54
1 1/2" x 1 1/4"	-	-	-	-	26165W-B	1	20	31
2"	-	-	-	-	26107W-B	1	20	50
2" x 1 1/2"	-	-	-	-	26176W-B	1	15	34

FEMALE STRAIGHT CONNECTOR

Push x FIP

1/4" x 1/2"	-	-	-	-	26220W-B	6	180	20
3/8" x 1/2"	-	-	-	-	26212W-B	6	180	19
1/2"	26202W	20	200	24	26202W-B	12	180	21
1/2" x 3/4"	26223W	20	200	32	26223W-B	6	150	25
3/4"	26203W	12	120	24	26203W-B	6	90	18
3/4" x 1/2"	-	-	-	-	26232W-B	6	180	23
3/4" x 1"	-	-	-	-	26234W-B	6	90	22
1"	26204W	9	90	24	26204W-B	6	90	25
1 1/4"	-	-	-	-	26205W-B	1	30	26
1 1/2"	-	-	-	-	26206W-B	1	25	33
2"	-	-	-	-	26207W-B	1	20	34

MALE STRAIGHT CONNECTOR

Push x MIP

1/4" x 1/2"	-	-	-	-	26320W-B	6	180	18
3/8" x 1/2"	-	-	-	-	26312W-B	6	180	18
1/2"	26302W	20	200	22	26302W-B	12	180	20
1/2" x 3/4"	26323W	20	200	34	26323W-B	6	120	20
3/4"	26303W	15	150	27	26303W-B	12	120	22
3/4" x 1/2"	-	-	-	-	26332W-B	6	150	20
3/4" x 1"	-	-	-	-	26334W-B	6	90	24
1" x 3/4"	26343W	9	90	21	26343W-B	6	90	20
1"	26304W	9	90	23	26304W-B	6	90	23
1 1/4"	-	-	-	-	26305W-B	1	30	26
1 1/2"	-	-	-	-	26306W-B	1	25	32
2"	-	-	-	-	26307W-B	1	20	33

POLYBUTYLENE ADAPTER

Push x Push PB

1/2"	-	-	-	-	26192W-B	6	120	16
3/4"	-	-	-	-	26193W-B	6	90	17



Pro-Connect ProPush™ Slip Coupling
 Forged Dezincification Resistant Brass Fitting
 For Connection to Copper, CPVC or PEX • Lead-Free

200 PSI/200° F
ISO 9001



INDIVIDUALLY PACKED

Certified to ASSE 1061 & NSF/ANSI 61-G

BULK PACKED

Certified to ASSE 1061 & NSF/ANSI 61-G

SIZE **ITEM #** **P/CARTON** **P/CASE** **WT/CASE** **ITEM #** **P/CARTON** **P/CASE** **WT/CASE**

Push

1/2"	26122W	15	150	33	26122W-B	3	90	21
3/4"	26133W	5	50	18	26133W-B	3	60	22
1"	26144W	5	50	26	26144W-B	1	50	24



SIMPLY THE BEST
PUSH CONNECT FITTING
PROGRAM IN THE INDUSTRY

WITH YOUR CHOICE OF BULK OR INDIVIDUALLY PACKED PRODUCTS



Pro-Connect ProPush™ Elbow
 Forged Dezincification Resistant Brass Fitting
 For Connection to Copper, CPVC or PEX • **Lead-Free**

200 PSI/200° F
ISO 9001



INDIVIDUALLY PACKED
 Certified to ASSE 1061 & NSF/ANSI 61-G

BULK PACKED
 Certified to ASSE 1061 & NSF/ANSI 61-G

SIZE	ITEM #	P/CARTON	P/CASE	WT/CASE	ITEM #	P/CARTON	P/CASE	WT/CASE
90° ELBOW								
Push								
1/4"	-	-	-	-	26400W-B	6	360	25
3/8"	-	-	-	-	26401W-B	6	180	22
1/2"	26402W	20	200	30	26402W-B	12	180	26
1/2" x 3/8"	-	-	-	-	26421W-B	12	180	27
3/4"	26403W	12	120	32	26403W-B	12	96	26
3/4" x 1/2"	26432W	12	120	24	26432W-B	6	120	25
1"	26404W	10	100	47	26404W-B	6	60	28
1" x 3/4"	-	-	-	-	26443W-B	3	60	23
1 1/4"	-	-	-	-	26405W-B	1	20	28
1 1/2"	-	-	-	-	26406W-B	1	15	36
2"	-	-	-	-	26407W-B	1	8	26
Push x FIP								
1/2"	26422W	20	200	30	26422W-B	6	150	26
Push x MIP								
1/2"	26222W	20	200	30	26222W-B	6	120	22
3/4"	-	-	-	-	26233W-B	6	90	26
90° DROP EAR ELBOW								
Push								
1/2"	26462W	9	90	20	26462W-B	12	120	26
Push x FIP								
1/2"	26412W	9	90	20	26412W-B	6	120	24
3/4"	-	-	-	-	26413W-B	6	90	32
90° HY-EAR ELBOW								
Push x FIP								
1/2"	-	-	-	-	26412WHE-B	6	120	31



Pro-Connect ProPush™ Tee
 Forged Dezincification Resistant Brass Fitting
 For Connection to Copper, CPVC or PEX • **Lead-Free**

200 PSI/200° F
ISO 9001



INDIVIDUALLY PACKED
 Certified to ASSE 1061 & NSF/ANSI 61-G

BULK PACKED
 Certified to ASSE 1061 & NSF/ANSI 61-G

SIZE	ITEM #	P/CARTON	P/CASE	WT/CASE	ITEM #	P/CARTON	P/CASE	WT/CASE
TEE								
Push								
1/4"	-	-	-	-	26500W-B	6	300	21
3/8"	-	-	-	-	26501W-B	6	150	25
3/8" x 3/8" x 1/2"	-	-	-	-	26512W-B	6	120	21
1/2"	26502W	12	120	24	26502W-B	12	120	21
1/2" x 1/2" x 1/4"	-	-	-	-	26520W-B	6	120	21
1/2" x 1/2" x 3/8"	-	-	-	-	26521W-B	6	120	24
3/4"	26503W	12	120	42	26503W-B	6	60	21
3/4" x 1/2" x 1/2"	26522W	18	180	43	26522W-B	6	90	23
3/4" x 3/4" x 1/2"	26532W	15	150	47	26532W-B	6	60	19
3/4" x 1/2" x 3/4"	26533W	12	120	38	26533W-B	6	60	20
1"	26504W	6	60	37	26504W-B	3	30	19
1" x 1" x 3/4"	26543W	6	60	29	26543W-B	3	30	15
1 1/4"	-	-	-	-	26505W-B	1	15	30
1 1/2"	-	-	-	-	26506W-B	1	10	31
2"	-	-	-	-	26507W-B	1	6	28
REPAIR TEE								
Push								
1/2"	26702W	8	80	25	26702W-B	3	90	28
3/4"	26703W	6	60	31	26703W-B	3	60	31
Push x Push x FIP								
1/2"	26722W	8	80	26	26722W-B	3	90	28
3/4"	26733W	6	60	32	26733W-B	3	60	31
Push x Push x CTS Slip								
1/2"	-	-	-	-	26752W-B	6	60	18



Pro-Connect ProPush™ End Cap
 Forged Dezincification Resistant Brass Fitting • For Connection to Copper, CPVC or PEX • **Lead-Free**

200 PSI/200° F
ISO 9001



INDIVIDUALLY PACKED
 Certified to ASSE 1061 & NSF/ANSI 61-G

BULK PACKED
 Certified to ASSE 1061 & NSF/ANSI 61-G

SIZE	ITEM #	P/CARTON	P/CASE	WT/CASE	ITEM #	P/CARTON	P/CASE	WT/CASE
Push								
3/8"	-	-	-	-	26601W-B	6	300	20
1/2"	26602W	30	300	21	26602W-B	12	300	20
3/4"	26603W	20	200	22	26603W-B	6	150	18
1"	26604W	12	120	23	26604W-B	6	120	23
1 1/4"	-	-	-	-	26605W-B	1	40	25
1 1/2"	-	-	-	-	26606W-B	1	35	37
2"	-	-	-	-	26607W-B	1	30	46



Pro-Connect ProPush™ Ball Valve

Pro-Connect ProPush™ Full Port Forged Dezincification Resistant Brass Ball Valve
w/ Adjustable Packing Gland • For Connection to Copper, CPVC or PEX • **Lead-Free**

200 PSI/200° F
ISO 9001



INDIVIDUALLY PACKED

Certified to ASSE 1061,
NSF/ANSI 61-G, IAPMO/ANSI Z1157

BULK PACKED

Certified to ASSE 1061,
NSF/ANSI 61-G, IAPMO/ANSI Z1157

SIZE	ITEM #	P/CARTON	P/CASE	WT/CASE	ITEM #	P/CARTON	P/CASE	WT/CASE
Push								
1/2"	62702W	10	100	43	62702W-B	12	72	32
3/4"	62703W	10	100	62	62703W-B	12	48	31
1"	62704W	5	50	55	62704W-B	6	24	28



Pro-Connect ProPush™ In-Line Spring Check Valve

Forged Dezincification Resistant Brass Fitting
For Connection to Copper, CPVC or PEX • **Lead-Free**

200 PSI/200° F
ISO 9001



INDIVIDUALLY PACKED

Certified to ASSE 1061 & NSF/ANSI 61-G

BULK PACKED

Certified to ASSE 1061 & NSF/ANSI 61-G

SIZE	ITEM #	P/CARTON	P/CASE	WT/CASE	ITEM #	P/CARTON	P/CASE	WT/CASE
Push								
1/2"	-	-	-	-	26992W-B	6	120	19
3/4"	26993W	12	120	38	26993W-B	6	72	23
1"	-	-	-	-	26994W-B	3	45	24



Pro-Connect ProPush™ 1/4 Turn Supply Stop

Forged Dezincification Resistant Brass Fitting
For Connection to Copper, CPVC or PEX • **Lead-Free**

ISO 9001



INDIVIDUALLY PACKED

Certified to ASSE 1061, NSF/ANSI 61,
NSF/ANSI 372, ASME A112.18.6/CSA B125.6,
IAPMO/ANSI Z1157

BULK PACKED

Certified to ASSE 1061, NSF/ANSI 61,
NSF/ANSI 372, ASME A112.18.6/CSA B125.6,
IAPMO/ANSI Z1157

SIZE	ITEM #	P/CARTON	P/CASE	WT/CASE	ITEM #	P/CARTON	P/CASE	WT/CASE
ANGLED								
Push × OD Compression								
1/2" × 1/4"	26820W	20	200	52	26820W-B	6	120	32
1/2" × 3/8"	26821W	20	200	52	26821W-B	12	120	32
STRAIGHT								
Push × OD Compression								
1/2" × 1/4"	26920W	20	200	48	26920W-B	6	120	29
1/2" × 3/8"	26921W	20	200	48	26921W-B	12	120	30



Pro-Connect ProPush™ Flexible Water Heater Connector

Braided Stainless Steel
For Connection to Copper, CPVC or PEX • **Lead-Free**

ISO 9001



INDIVIDUALLY PACKED

Certified to ASSE 1061, NSF/ANSI 61-G,
ASME A112.18.6/CSA B125.6

BULK PACKED

Certified to ASSE 1061, NSF/ANSI 61-G,
ASME A112.18.6/CSA B125.6

SIZE	ITEM #	P/CARTON	P/CASE	WT/CASE	ITEM #	P/CARTON	P/CASE	WT/CASE
Push × FIP								
1/2" × 3/4"	-	-	-	-	26023W-12-B	12	60	17
1/2" × 3/4"	-	-	-	-	26023W-15-B	12	60	19
1/2" × 3/4"	26023W-18	1	50	20	26023W-18-B	12	60	21
1/2" × 3/4"	-	-	-	-	26023W-24-B	12	60	24
3/4"	26033W-12	1	50	30	26033W-12-B	12	48	30
3/4"	26033W-15	1	50	32	26033W-15-B	12	48	32
3/4"	26033W-18	1	50	40	26033W-18-B	12	36	31
3/4"	26033W-24	1	50	43	26033W-24-B	12	36	35

W/ FULL PORT FORGED BRASS DEZINCIFICATION RESISTANT BRASS BALL VALVE

Certified to ASSE 1061, NSF/ANSI 61-G, ASME A112.18.6/CSA B125.6, IAPMO/ANSI Z1157

SIZE	ITEM #	P/CARTON	P/CASE	WT/CASE	ITEM #	P/CARTON	P/CASE	WT/CASE
Push × FIP								
1/2" × 3/4"	62023W-18	1	25	18	62023W-18-B	12	48	39
3/4"	62033W-18	1	25	30	62033W-18-B	12	36	33



Exclusive Lifetime Warranty AND
10 for 1 Replacement Guarantee

See www.webstonevalves.com/web_warranty for full details.

GET STARTED WITH THE CONTRACTOR PUSH FITTING KIT

27-Piece assortment includes:



1/2" PUSH × PUSH STRAIGHT COUPLING 	3/4" PUSH × PUSH STRAIGHT COUPLING 	1/2" PUSH × FIP STRAIGHT CONNECTOR 	3/4" PUSH × FIP STRAIGHT CONNECTOR
1/2" PUSH × MIP STRAIGHT CONNECTOR 	3/4" PUSH × MIP STRAIGHT CONNECTOR 	1/2" PUSH 90° ELBOW 	3/4" PUSH 90° ELBOW
1/2" PUSH TEE 	3/4" PUSH TEE 	1/2" PEX ADAPTER (2 SETS) 3/4" PEX ADAPTER (2 SETS) 	1/2" REMOVAL TOOL 3/4" REMOVAL TOOL
			1/2" PUSH END CAP 3/4" PUSH END CAP



Contractor Push Fitting Kit

27-Piece Assortment Includes all the Fittings and Tools For Connection to Copper, CPVC or PEX

200 PSI/200° F



LEAD-FREE BRASS

Certified to ASSE 1061 & NSF/ANSI 61-G

SIZE	ITEM #	P/CARTON	P/CASE	WT/CASE
KIT	26000WKIT	1	4	29



Pro-Connect ProPush™ Water Heater Installation Kit

Includes: (2) Push × FIP Straight Connectors & Removal Tool For Connection to Copper, CPVC or PEX • **Lead-Free**

200 PSI/200° F
ISO 9001



INDIVIDUALLY PACKED

Certified to ASSE 1061 & NSF/ANSI 61-G

BULK PACKED

Certified to ASSE 1061 & NSF/ANSI 61-G

SIZE	ITEM #	P/CARTON	P/CASE	WT/CASE	ITEM #	P/CARTON	P/CASE	WT/CASE
FIP								
3/4"	26203WKIT	5	50	28	26203WKIT-B	12	72	29
1/2" × 3/4"	26223WKIT	5	50	28	26223WKIT-B	12	72	24



Pro-Connect ProPush™ Tap-A-Line Kit

Includes Repair Tee, Copper Tube Stub, Straight Supply Stop & Removal Tool For Connection to Copper, CPVC or PEX • **Lead-Free**

200 PSI/200° F
ISO 9001



BULK PACKED

Certified to ASSE 1061, NSF/ANSI 61, NSF/ANSI 372, ASME A112.18.6/CSA B125.6, IAPMO/ANSI Z1157 & NSF/ANSI 61-G

SIZE	ITEM #	P/CARTON	P/CASE	WT/CASE
Push × OD Comp				
1/2" × 1/4"	26920WKIT-B	12	72	40
1/2" × 3/8"	26921WKIT-B	12	72	40
3/4" × 1/4"	26930WKIT-B	6	60	54

TAP-A-LINE KIT

ADD A NEW SUPPLY LINE IN JUST MINUTES

PEX Adapter Set

ISO 9001



SIZE	INDIVIDUALLY PACKED				BULK PACKED			
	ITEM #	P/CARTON	P/CASE	WT/CASE	ITEM #	P/CARTON	P/CASE	WT/CASE
1/2"	28212	1	300	1	28212-B	1	100	1
3/4"	28213	1	300	1	28213-B	1	100	1
1"	28214	1	250	3	28214-B	1	100	1

Pro-Connect ProPush™ Removal Tool

ISO 9001



SIZE	INDIVIDUALLY PACKED				BULK PACKED			
	ITEM #	P/CARTON	P/CASE	WT/CASE	ITEM #	P/CARTON	P/CASE	WT/CASE
1/4" - 1"								
1/4"	-	-	-	-	28110-B	24	1200	9
3/8"	-	-	-	-	28111-B	24	1200	8
1/2"	28112	1	300	2	28112-B	24	1200	8
3/4"	28113	1	300	4	28113-B	24	600	10
1"	28114	1	250	6	28114-B	12	600	15
1 1/4" - 2"								
1 1/4"	-	-	-	-	28115-B	1	50	33
1 1/2"	-	-	-	-	28116-B	1	50	44
2"	-	-	-	-	28117-B	1	50	64

Deburr & Gauge Tool

ISO 9001



SIZE	BULK PACKED			
	ITEM #	P/CARTON	P/CASE	WT/CASE
TOOL	28000-B	1	50	6

PRO-CONNECT UNIVERSAL™



MAKE ANY 1/2" THRU 2" SWT VALVE INTO A PRO-CONNECT UNIVERSAL™

The PRO-CONNECT Universal™ series is a full line of heavy duty brass valves featuring 2" copper tube-sized male extensions; ideal for soldering or use with any solder-less crimp systems or quick-connect fittings available on the market today. Any Webstone sweat ball valve, gate valve, check valve, or globe valve sized 1/2" to 2" can be converted to PRO-CONNECT Universal™ according to your needs.

- Heavy duty valves with pre-assembled 2" copper extensions
- Available on virtually any Webstone SWT valve
- A universal solution for solder, press, or push connections!
- 100% tested, cleaned & capped

COMMITMENT TO QUALITY

PRO-CONNECT Universal™ extensions are machine soldered, de-burred, cleaned, polished, and 100% tested assuring a perfect connection every time. Each extension is outfitted with plastic caps to preserve the integrity of the copper right up until installation.

All PRO-CONNECT Universal™ valves are soldered and packaged to order. In most cases your order will ship within 24 hours; larger orders may take a day or two more.*

TO ORDER

Add an "X" and the number of extensions to the end of the part number of the valve you wish to purchase. See Webstone's current List Price Guide and add the appropriate list price per extension to the list price of the valve you wish to purchase.

FOR EXAMPLE

51703X2 is a 3/4" Full Port Brass Ball Valve with extensions on 2 ends.
58644X4 is a 1" x 1" Primary/Secondary Purge Tee with extensions on 4 ends.

*Orders for Pro-Connect Universal™ products are considered a final sale and may not be returned with the exception of manufacturer defect.

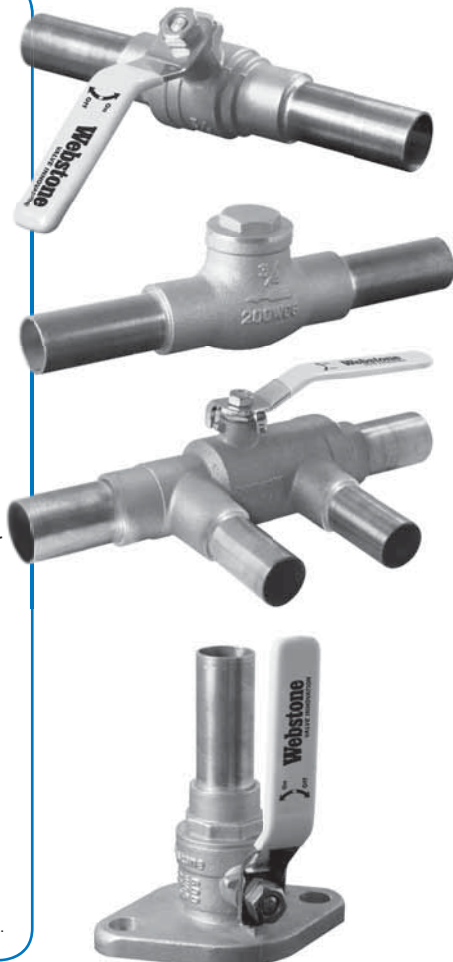



Pro-Connect ProPush™ In-Line Spring Check Valve

Forged Dezincification Resistant Brass Fitting

For Connection to Copper, CPVC or PEX • Lead-Free

200 PSI/200° F
ISO 9001



INDIVIDUALLY PACKED

Certified to ASSE 1061 & NSF/ANSI 61-G

SIZE	ITEM #	P/CARTON	P/CASE	WT/CASE
Push				
1/2"	-	-	-	-
3/4"	26993W	12	120	38
1"	-	-	-	-

BULK PACKED

Certified to ASSE 1061 & NSF/ANSI 61-G

ITEM #	P/CARTON	P/CASE	WT/CASE
26992W-B	6	120	19
26993W-B	6	72	23
26994W-B	3	45	24

Brass In-Line Spring Check Valve

316 Stainless Steel Spring – Celcon Poppet – Soft Seat

300 PSI
ISO 9001



LEAD-FREE BRASS

Certified to NSF/ANSI 61-G

SIZE	ITEM #	P/CARTON	P/CASE	WT/CASE
IPS				
3/8"	10701W	60	240	41
1/2"	10702W	10	100	28
3/4"	10703W	7	70	29
1"	10704W	5	50	30
1 1/4"	10705W	5	40	39
1 1/2"	10706W	5	30	35
2"	10707W	2	20	37

B62 Bronze (85-5-5-5) Swing Check Valve

Hard Seat

300 WOG/150 WSP
ISO 9001



STANDARD BRASS

SIZE	ITEM #	P/CARTON	P/CASE	WT/CASE
IPS				
3/8"	10501	10	120	52
1/2"	10502	10	120	53
3/4"	10503	10	80	50
1"	10504	5	60	48
1 1/4"	10505	5	40	58
1 1/2"	10506	5	30	55
2"	10507	2	24	67
2 1/2"	10508	1	12	55
3"	10509	1	8	56
4"	10510	1	4	43

Forged Brass Swing Check Valve

Hard Seat

200 WOG/125 WSP
ISO 9001



LEAD-FREE BRASS

Certified to NSF/ANSI 61-G

SIZE	ITEM #	P/CARTON	P/CASE	WT/CASE
IPS				
1/4"	10540W	12	120	26
3/8"	10541W	10	120	34
1/2"	10542W	10	120	48
3/4"	10543W	10	80	48
1"	10544W	5	60	50
1 1/4"	10545W	5	40	55
1 1/2"	10546W	5	30	59
2"	10547W	2	12	33
2 1/2"	10548W	2	8	37
3"	10549W	1	8	60
4"	10550W	1	4	46
SWT				
1/2"	10622W	10	120	49
3/4"	10623W	10	80	50
1"	10624W	5	60	53
1 1/4"	10625W	5	40	58
1 1/2"	10626W	5	30	62
2"	10627W	2	10	30

Forged Brass Swing Check Valve

Soft Seat

200 WOG/125 WSP
ISO 9001



STANDARD BRASS

SIZE	ITEM #	P/CARTON	P/CASE	WT/CASE
IPS				
1/2"	10522	12	120	49
3/4"	10523	10	80	46
1"	10524	5	60	46
1 1/4"	10525	5	40	54
1 1/2"	10526	5	30	55
2"	10527	2	24	71

Heavy Duty Forged Brass Gate Valve

Hard Seat

200 WOG
ISO 9001



STANDARD BRASS

LEAD-FREE BRASS

Certified to NSF/ANSI 61-G

SIZE IPS	STANDARD BRASS				LEAD-FREE BRASS			
	ITEM #	P/CARTON	P/CASE	WT/CASE	ITEM #	P/CARTON	P/CASE	WT/CASE
1/2"	-	-	-	-	10132W	10	100	49
3/4"	-	-	-	-	10133W	10	100	70
1"	-	-	-	-	10134W	5	50	47
1 1/4"	-	-	-	-	10135W	5	30	51
1 1/2"	-	-	-	-	10136W	2	30	62
2"	10137	2	20	57	10137W	2	20	57
2 1/2"	10138	1	10	48	10138W	1	10	49
3"	10139	1	10	73	10139W	1	10	72
4"	10140	1	4	49	10140W	1	4	48

Certification applies to 2" Only

Heavy Pattern Bronze Gate Valve

Hard Seat

300 WOG/150 WSP
ISO 9001



STANDARD BRASS

SIZE IPS	ITEM #	P/CARTON	P/CASE	WT/CASE
1/2"	10102	10	100	63
3/4"	10103	6	60	55
1"	10104	5	40	54
1 1/4"	10105	5	30	56
1 1/2"	10106	4	24	58
2"	10107	4	16	60
2 1/2"	10108	2	8	55
3"	10109	1	6	56
4"	10110	1	4	69

GLOBE VALVES

Brass Globe Valve

Straight - Hard Seat

200 WOG/125 WSP
ISO 9001



STANDARD BRASS

SIZE IPS	ITEM #	P/CARTON	P/CASE	WT/CASE
1/4"	10400	10	120	58
3/8"	10401	10	120	60
1/2"	10402	10	120	64
3/4"	10403	10	80	58
1"	10404	5	40	44
1 1/4"	10405	5	30	48
1 1/2"	10406	4	24	53
2"	10407	2	16	59

Brass Stop Valve (Globe)

Straight - Soft Seat

200 WOG
ISO 9001



STANDARD BRASS

SIZE IPS	ITEM #	P/CARTON	P/CASE	WT/CASE
1/2"	11802	12	72	40
3/4"	11803	12	72	45
1"	11804	5	40	42
1 1/4"	11805	5	30	51
1 1/2"	11806	4	24	59
2"	11807	2	16	60

Full Flow Forged Brass Silcock

Nickel Plated w/ 1/4 Turn Action & Stainless Steel Lever Handle

125 WOG
ISO 9001



LEAD-FREE BRASS

SIZE	ITEM #	P/CARTON	P/CASE	WT/CASE
ASTM F1960 PEX Flange x 3/4" Male Hose				
1/2"	33202WSSL	12	72	58

Forged Brass Silcock

Nickel Plated w/ 1/4 Turn Handle

125 WOG
ISO 9001



LEAD-FREE BRASS

SIZE	ITEM #	P/CARTON	P/CASE	WT/CASE
FIP Flange x Hose				
1/2"	30202W	12	72	42
3/4"	30203W	12	72	58

Brass Frost Free Silcock

Chrome Plated w/ Integral Vacuum Breaker

125 WOG
ISO 9001



LEAD-FREE BRASS

Certified to NSF/ANSI 61-G

LENGTH	ITEM #	P/CARTON	P/CASE	WT/CASE
1/2" MIP or SWT x Hose				
6"	11832W	2	24	25
8"	11834W	2	24	26
10"	11836W	2	24	28
12"	11838W	2	24	30
14"	11840W	2	24	31

Forged Brass Hose Bibb

w/ Ball Valve Action

125 WOG
ISO 9001



LEAD-FREE BRASS

Certified to NSF/ANSI 61-G

SIZE	ITEM #	P/CARTON	P/CASE	WT/CASE
MIP x Hose				
1/2"	30314W	12	72	34
3/4"	30316W	12	72	38

*1/2 MIP or SWT x HOSE

Brass Hose Bibb

No Kink, w/ 1/4 Turn Handle

125 WOG
ISO 9001



LEAD-FREE BRASS

Certified to NSF/ANSI 61-G

SIZE	ITEM #	P/CARTON	P/CASE	WT/CASE
MIP x Hose				
1/2"	30218W	12	72	22
3/4"	30219W	12	72	25

Brass Garden Valve

Bent Nose w/ Oval Handle

125 PSI
ISO 9001



LEAD-FREE BRASS

SIZE	ITEM #	P/CARTON	P/CASE	WT/CASE
FIP x Hose				
3/4"	30213W	12	72	45
1"	30214W	12	72	49

Brass Hose Bibb Vacuum Breaker

Anti-Siphon Device w/ Flat Washer (CP= Chrome Plated)

150 PSI
ISO 9001



LEAD-FREE BRASS

Certified to NSF/ANSI 61-G

SIZE	ITEM #	P/CARTON	P/CASE	WT/CASE
Hose				
3/4"	11850W	12	144	32
3/4"	11850W-CP	12	144	32



Pro-Connect ProPush™ 1/4 Turn Supply Stop

Forged Dezincification Resistant Brass Fitting
For Connection to Copper, CPVC or PEX • Lead-Free

ISO 9001



INDIVIDUALLY PACKED

Certified to ASSE 1061, NSF/ANSI 61, NSF/ANSI 372, ASME A112.18.6/CSA B125.6, IAPMO/ANSI Z1157

BULK PACKED

Certified to ASSE 1061, NSF/ANSI 61, NSF/ANSI 372, ASME A112.18.6/CSA B125.6, IAPMO/ANSI Z1157

SIZE	ITEM #	P/CARTON	P/CASE	WT/CASE	ITEM #	P/CARTON	P/CASE	WT/CASE
ANGLED								
Push x OD Compression								
1/2" x 1/4"	26820W	20	200	52	26820W-B	6	120	32
1/2" x 3/8"	26821W	20	200	52	26821W-B	12	120	32
STRAIGHT								
Push x OD Compression								
1/2" x 1/4"	26920W	20	200	48	26920W-B	6	120	29
1/2" x 3/8"	26921W	20	200	48	26921W-B	12	120	30

1/4 Turn Supply Stop

Chrome Plated Extruded Brass — Angled

ISO 9001



LEAD-FREE BRASS

Certified to NSF/ANSI 61-G

SIZE	ITEM #	P/CARTON	P/CASE	WT/CASE
FIP x OD Comp				
3/8"	11900W	20	120	20
1/2" x 3/8"	11901W	20	120	22
OD SWT x OD Comp				
5/8" x 3/8"	11905W	20	120	20
OD Comp				
5/8" x 3/8"	11908W	20	120	26

11900W/11901W not ISO

1/4 Turn Supply Stop

Chrome Plated Extruded Brass — Straight

ISO 9001



LEAD-FREE BRASS

Certified to NSF/ANSI 61-G

SIZE	ITEM #	P/CARTON	P/CASE	WT/CASE
FIP x OD Comp				
3/8"	11940W	20	120	18
1/2" x 3/8"	11941W	20	120	22
OD SWT x OD Comp				
5/8" x 3/8"	11945W	20	120	20
OD Comp				
5/8" x 3/8"	11948W	20	120	24

Certifications do not apply to 11940W/11941W • 11940W/11941W not ISO

Supply Stop

Chrome Plated Extruded Brass – Celcon Stem – Angled

ISO 9001



LEAD-FREE BRASS

Certified to NSF/ANSI 61-G

SIZE	ITEM #	P/CARTON	P/CASE	WT/CASE
FIP x OD Comp				
3/8"	11900W-C	10	100	18
1/2" x 3/8"	11901W-C	10	100	25
OD Comp				
5/8" x 3/8"	11908W-C	10	100	21

Supply Stop

Chrome Plated Extruded Brass – Celcon Stem – Straight

ISO 9001



LEAD-FREE BRASS

Certified to NSF/ANSI 61-G

SIZE	ITEM #	P/CARTON	P/CASE	WT/CASE
FIP x OD Comp				
3/8"	11940W-C	10	100	23
1/2" x 3/8"	11941W-C	10	100	31
OD Comp				
5/8" x 3/8"	11948W-C	10	100	26

Exclusive 10 for 1 Warranty:

If a Webstone Supply Stop ever fails due to a manufacturing defect...

WE'LL REPLACE IT WITH 10 NEW ONES.

Bronze Wye Strainer 20 Mesh Screen

300 WOG/150 WSP
ISO 9001

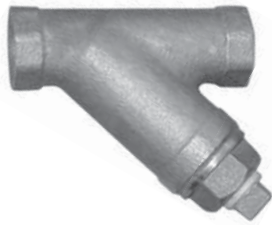

SIZE	ITEM #	P/CARTON	P/CASE	WT/CASE
IPS				
1/2"	10562	12	60	49
3/4"	10563	8	48	59
1"	10564	8	32	58
1 1/4"	10565	8	32	85
1 1/2"	10566	2	16	56
2"	10567	2	8	47

UNIONS

PVC Union

Fits Schedule 40 & 80 Pipe — White

ISO 9001



SIZE	ITEM #	P/CARTON	P/CASE	WT/CASE
Socket Ends				
1/2"	04822	1	320	45
3/4"	04823	1	72	13
1"	04824	1	126	37
1 1/4"	04825	1	64	31
1 1/2"	04826	1	36	26
2"	04827	1	32	42
2 1/2"	04828	1	12	27
3"	04829	1	12	37
4"	04830	1	8	43
IPS				
1/2"	04832	1	320	54
3/4"	04833	1	72	14
1"	04834	1	60	18
1 1/4"	04835	1	64	32
1 1/2"	04836	1	48	35
2"	04837	6	24	31

CPVC Union

Fits CPVC Pipe (Copper Tubing Size)

ISO 9001



SIZE	ITEM #	P/CARTON	P/CASE	WT/CASE
Socket Ends				
1/2"	03742	16	96	13
3/4"	03743	12	96	17

Dielectric Union

Galvanized Steel & Brass – Nylon Insulator Ring

Max Temp 232° F
ISO 9001



LEAD-FREE BRASS

SIZE	ITEM #	P/CARTON	P/CASE	WT/CASE
FIP x SWT				
1/2"	01102W	24	144	45
3/4"	01103W	24	96	38
3/4" x 1/2"	01132W	24	96	44
1"	01104W	12	96	52
1 1/4"	01105W	6	48	39
1 1/2"	01106W	6	36	48
2"	01107W	6	18	44

PART NUMBER	PAGE	PART NUMBER	PAGE	PART NUMBER	PAGE	PART NUMBER	PAGE	PART NUMBER	PAGE
01102W	41	10547W	37	25011	29	26462W	33	40407HV	18
01103W	41	10548W	37	26000WKIT	35	26462W-B	33	40413/40413HV	18
01104W	41	10549W	37	26023W-12-B	34	26500W-B	33	40413KIT/40413HVKIT	19
01105W	41	10550W	37	26023W-15-B	34	26501W-B	33	40414/40414HV	18
01106W	41	10562	41	26023W-18	34	26502W	33	40414KIT/40414HVKIT	19
01107W	41	10563	41	26023W-18-B	34	26502W-B	33	40415/40415HV	18
01132W	41	10564	41	26023W-24-B	34	26503W	33	40415KIT/40415HVKIT	19
03722	12	10565	41	26033W-12	34	26503W-B	33	40416/40416HV	18
03723	12	10566	41	26033W-12-B	34	26504W	33	40417HV	18
03724	12	10567	41	26033W-15	34	26504W-B	33	40433	17
03725	12	10622W	37	26033W-15-B	34	26505W-B	33	40433W	17
03726	12	10623W	37	26033W-18	34	26506W-B	33	40434	17
03727	12	10624W	37	26033W-18-B	34	26507W-B	33	40434W	17
03742	41	10625W	37	26033W-24	34	26512W-B	33	40435	17
03743	41	10626W	37	26033W-24-B	34	26520W-B	33	40435W	17
03822	12	10627W	37	26100W-B	32	26521W-B	33	40436	17
03823	12	10701W	37	26101W	32	26522W	33	40436W	17
03824	12	10702W	37	26101W-B	32	26522W-B	33	40443W	30
03825	12	10703W	37	26102W	32	26532W	33	40443WCOM	31
03826	12	10704W	37	26102W-B	32	26532W-B	33	40443WPR	30
03827	12	10705W	37	26103W	32	26533W	33	40443WPR2	30
03828	12	10706W	37	26103W-B	32	26533W-B	33	40530W	11
03829	12	10707W	37	26104W	32	26543W	33	40531W	11
03830	12	11401	29	26104W-B	32	26543W-B	33	40532W	11
03831	12	11403	29	26105W-B	32	26601W-B	33	40533W	11
03922	12	11511	28	26106W-B	32	26602W	33	40534W	11
03923	12	11512	28	26107W-B	32	26602W-B	33	40612	17
03924	12	11513	28	26112W	32	26603W	33	40612W	17
03925	12	11515-A	28	26112W-B	32	26603W-B	33	40613	17
03926	12	11516	29	26120W-B	32	26604W	33	40613W	17
03927	12	11517	29	26122W	32	26604W-B	33	40614	17
04602	12	11523	28	26122W-B	32	26605W-B	33	40614W	17
04603	12	11524	28	26132W	32	26606W-B	33	40615	17
04604	12	11525	28	26132W-B	32	26607W-B	33	40615W	17
04605	12	11526	28	26133W	32	26702W	33	40616	17
04606	12	11533	28	26133W-B	32	26702W-B	33	40616W	17
04607	12	11533-E	28	26143W	32	26703W	33	40617	17
04822	41	11533-T	28	26143W-B	32	26703W-B	33	40617W	17
04823	41	11534	28	26144W	32	26722W	33	40622W	11
04824	41	11534-E	28	26144W-B	32	26722W-B	33	40623W	11
04825	41	11534-T	28	26154W-B	32	26733W	33	40624W	11
04826	41	11535	28	26165W-B	32	26733W-B	33	40632W	11
04827	41	11535-E	28	26176W-B	32	26752W-B	33	40633W	11
04828	41	11535-T	28	26192W-B	32	26820W	34, 40	40634W	11
04829	41	11536	28	26193W-B	32	26820W-B	34, 40	40642	10
04830	41	11553	28	26202W	32	26821W	34, 40	40643	10
04832	41	11554	28	26202W-B	32	26821W-B	34, 40	40644	10
04833	41	11555	28	26203W	32	26920W	34, 40	40782	14, 15
04834	41	11556	28	26203W-B	32	26920W-B	34, 40	40790	14
04835	41	11603	28	26203WKIT	35	26920WKIT-B	35	40791	14
04836	41	11700W	29	26203WKIT-B	35	26921W	34, 40	40792	14
04837	41	11701W	29	26204W	32	26921W-B	34, 40	40793	14
10102	38	11702W	29	26204W-B	32	26921WKIT-B	35	40794	14
10103	38	11703W	29	26205W-B	32	26930WKIT-B	35	40795	14
10104	38	11704W	29	26206W-B	32	26992W-B	34, 37	40796	14
10105	38	11705W	29	26207W-B	32	26993W	34, 37	40798	14
10106	38	11709	29	26212W-B	32	26993W-B	34, 37	40800W	10
10107	38	11710W	29	26220W-B	32	26994W-B	34, 37	40801W	10
10108	38	11711W	29	26222W	33	28000-B	36	40802W	10
10109	38	11712	29	26222W-B	33	28003	31	40803W	10
10110	38	11802	38	26223W	32	28023W	31	40804W	10
10132W	38	11803	38	26223W-B	32	28110-B	36	40805W	10
10133W	38	11804	38	26223WKIT	35	28111-B	36	40806W	10
10134W	38	11805	38	26223WKIT-B	35	28112	36	40807W	10
10135W	38	11806	38	26232W-B	32	28112-B	36	41403/41403HV	18
10136W	38	11807	38	26233W-B	33	28113	36	41403W/41403WHV	18
10137	38	11832W	39	26234W-B	32	28113-B	36	41404/41404HV	18
10137W	38	11834W	39	26302W	32	28114	36	41404W/41404WHV	18
10138	38	11836W	39	26302W-B	32	28114-B	36	41405/41405HV	18
10138W	38	11838W	39	26303W	32	28115-B	36	41405W/41405WHV	18
10139	38	11840W	39	26303W-B	32	28116-B	36	41406/41406HV	18
10139W	38	11850W	39	26304W	32	28117-B	36	41406HV-RF375	20
10140	38	11850W-CP	39	26304W-B	32	28212	36	41406W/41406WHV	18
10140W	38	11900W	40	26305W-B	32	28212-B	36	41407HV-RF400	20
10400	38	11900W-C	40	26306W-B	32	28213	36	41407HV-RF475	20
10401	38	11901W	40	26307W-B	32	28213-B	36	41407WHV	18
10402	38	11901W-C	40	26312W-B	32	28214	36	41413/41413HV	19
10403	38	11905W	40	26320W-B	32	28214-B	36	41413KIT/41413HVKIT	19
10404	38	11908W	40	26323W	32	29003	31	41413W/41413WHV	19
10405	38	11908W-C	40	26323W-B	32	29003W	31	41413WKIT/41413WHVKIT	19
10406	38	11940W	40	26332W-B	32	30000W-P	27	41414/41414HV	19
10407	38	11940W-C	40	26334W-B	32	30000W-TP	27	41414KIT/41414HVKIT	19
10501	37	11941W	40	26343W	32	30202W	12, 39	41414W/41414WHV	19
10502	37	11941W-C	40	26343W-B	32	30203W	12, 39	41414WKIT/41414WHVKIT	19
10503	37	11945W	40	26400W-B	33	30213W	39	41415/41415HV	19
10504	37	11948W	40	26401W-B	33	30214W	39	41415KIT/41415HVKIT	19
10505	37	11948W-C	40	26402W	33	30218W	12, 39	41415W/41415WHV	19
10506	37	13703HV	20	26402W-B	33	30219W	12, 39	41415WKIT/41415WHVKIT	19
10507	37	13706HV	20	26403W	33	30314W	12, 39	41416/41416HV	19
10508	37	20103	28	26403W-B	33	30316W	12, 39	41416HV-RF375	20
10509	37	20713	31	26404W	33	31000	25, 27	41416W/41416WHV	19
10510	37	20713W	31	26404W-B	33	31702WSSW	9, 15	41417HV-RF400	20
10522	37	20723	31	26405W-B	33	31703WSSW	9, 15	41417HV-RF475	20
10523	37	20733	31	26406W-B	33	31704WSSW	9, 15	41417WHV	19
10524	37	21526	14	26407W-B	33	33202WSSL	11, 15, 39	41672	16
10525	37	21550	14	26412W	33	34702WSSW	10, 15	41685	14
10526	37	21551	14	26412W-B	33	34703WSSW	10, 15	41686	14
10527	37	21571	14	26412WHE-B	33	34704WSSW	10, 15	41687	14
10540W	37	21572	14	26413W-B	33	40312W	11	41698	14
10541W	37	22521	14	26421W-B	33	40313W	11	41699	14
10542W	37	22522	14	26422W	33	40402/40402HV	18	41700	8
10543W	37	22561	14	26422W-B	33	40403/40403HV	18	41700W	8
10544W	37	22562	14	26432W	33	40404/40404HV	18	41701	8
10545W	37	22563	14	26432W-B	33	40405/40405HV	18	41701W	8
10546W	37	22564	14	26443W-B	33	40406/40406HV	18	41702	8

PART NUMBER	PAGE	PART NUMBER	PAGE	PART NUMBER	PAGE	PART NUMBER	PAGE	PART NUMBER	PAGE
41702SSL	8	44443WPR-LF	30	51417HV-RF475	20	73103W-CAN	15, 26	84443WPR3	5, 31
41702SSW	8	44444PR3	31	51417WHV	19	73202W	15, 26	84443WPR-LF	5, 30
41702T	8	44444WPR	30	51702	8	73202W-CAN	15, 26	84444WPR	5, 30
41702W	8	44444WPR2	30	51702SSL	8	73203W	15, 26	84444WPR2	5, 30
41702WSSL	8	44444WPR3	31	51702SSW	8	73203W-CAN	15, 26	84444WPR3	5, 31
41702WSSW	8	44444WPR-LF	30	51702T	8	74000	26	84444WPR-LF	5, 30
41702WT	8	45443WCOM	31	51702W	8	74003	26	88354-43	24
41703	8	45443WPR	30	51702WSSL	8	74004	26	88354-44	24
41703SSL	8	45443WPR2	30	51702WSSW	8	74005	26	88354-53	24
41703SSW	8	45443WPR3	31	51702WT	8	74006	26	88354-54	24
41703T	8	48354-43	24	51703	8	74007	26	88754-43	24
41703W	8	48354-44	24	51703SSL	8	74102W	26	88754-44	24
41703WSSL	8	48613	16	51703SSW	8	74102W-CAN	26	88754-53	24
41703WSSW	8	48614	16	51703T	8	74103W	26	88754-54	24
41703WT	8	48615	16	51703W	8	74103W-CAN	26	88755-45	24
41704	8	48616	16	51703WSSL	8	74104W	26	88755-55	24
41704SSL	8	48754-43	24	51703WSSW	8	74104W-CAN	26	88764-44	24
41704SSW	8	48754-44	24	51703WT	8	74202W	26	88764-54	24
41704T	8	48755-45	24	51704	8	74202W-CAN	26	88765-45	24
41704W	8	48764-44	24	51704SSL	8	74203W	26	88765-55	24
41704WSSL	8	48765-45	24	51704SSW	8	74203W-CAN	26	88766-56	24
41704WSSW	8	48766-56	24	51704T	8	74204W	26	88854-43	24
41704WT	8	48854-43	24	51704W	8	74204W-CAN	26	88854-44	24
41705	8	48854-44	24	51704WSSL	8	74401W	26	88854-53	24
41705SSL	8	48855-45	24	51704WSSW	8	75003	26	88854-54	24
41705W	8	48864-44	24	51704WT	8	75004	26	88855-55	24
41705WSSL	8	48865-45	24	51705	8	75005	26	88864-44	24
41706	8	50312W	11	51705SSL	8	75006	26	88864-54	24
41706SSL	8	50313W	11	51705W	8	75007	26	88865-45	24
41706W	8	50402/50402HV	18	51705WSSL	8	75102W	26	88865-55	24
41706WSSW	8	50403/50403HV	18	51706	8	75102W-CAN	26	90613W	6, 17
41707	8	50404/50404HV	18	51706SSL	8	75103W	26	90614W	6, 17
41707SSL	8	50405/50405HV	18	51706W	8	75103W-CAN	26	90615W	6, 17
41707W	8	50406/50406HV	18	51706WSSL	8	75104W	26	90616W	6, 17
41707WSSL	8	50407HV	18	51707	8	75104W-CAN	26	90617W	6, 17
41708	8	50413/50413HV	18	51707SSL	8	75202W	26	91403WHV	6, 18
41708W	8	50413KIT/50413HVKIT	19	51707W	8	75202W-CAN	26	91404WHV	6, 18
41709	8	50414/50414HV	18	51707WSSL	8	75203W	26	91405WHV	6, 18
41709W	8	50414KIT/50414HVKIT	19	51708	8	75203W-CAN	26	91406WHV	6, 18
41710	8	50415/50415HV	18	51708W	8	75204W	26	91407WHV	6, 18
41710W	8	50415KIT/50415HVKIT	19	51709	8	75204W-CAN	26	91413WHV	6, 19
41722	11	50416/50416HV	18	51709W	8	78003	5, 26	91414WHV	6, 19
41723	11	50417HV	18	51710	8	78004	5, 26	91415WHV	6, 19
41724	11	50433	17	51710W	8	78005	5, 26	91416WHV	6, 19
41725	11	50433W	17	54443WCOM	31	78006	5, 26	91417WHV	6, 19
41726	11	50434	17	54443WPR	30	78007	5, 26	91702W	6, 9
41727	11	50434W	17	54443WPR2	30	78102W	5, 26	91703W	6, 9
41820	10	50435	17	54443WPR3	31	78102W-CAN	5, 26	91704W	6, 9
41820W	10	50435W	17	54443WPR-LF	30	78103W	5, 26	91705W	6, 9
41821	10	50436	17	54444PR3	31	78103W-CAN	5, 26	91706W	6, 9
41821W	10	50436W	17	54444WPR	30	78104W	5, 26	91707W	6, 9
41822	10	50443W	30	54444WPR2	30	78104W-CAN	5, 26	100613W	7, 17
41822W	10	50443WCOM	31	54444WPR3	31	78202W	5, 26	100614W	7, 17
41823	10	50443WPR	30	54444WPR-LF	30	78202W-CAN	5, 26	100615W	7, 17
41823W	10	50443WPR2	30	54612	17	78203W	5, 26	100616W	7, 17
41824	10	50612	17	54612W	17	78203W-CAN	5, 26	100617W	7, 17
41824W	10	50612W	17	54613	17	78204W	5, 26	101403WHV	7, 18
41825	10	50613	17	54613W	17	78204W-CAN	5, 26	101404WHV	7, 18
41825W	10	50613W	17	54614	17	80312W	4, 11	101405WHV	7, 18
41826	10	50614	17	54614W	17	80313W	4, 11	101406WHV	7, 18
41826W	10	50614W	17	55443WCOM	31	80612	5, 17	101407WHV	7, 18
41827	10	50615	17	55443WPR	30	80612W	5, 17	101413WHV	7, 19
41827W	10	50615W	17	55443WPR2	30	80613	5, 17	101414WHV	7, 19
41828	10	50616	17	55443WPR3	31	80613W	5, 17	101415WHV	7, 19
41828W	10	50616W	17	58354-43	24	80614	5, 17	101416WHV	7, 19
41829	10	50617	17	58354-53	24	80614W	5, 17	101417WHV	7, 19
41829W	10	50617W	17	58354-54	24	80615	5, 17	101702W	7, 9
41830	10	50622W	11	58613	16	80615W	5, 17	101703W	7, 9
41830W	10	50623W	11	58614	16	80616	5, 17	101704W	7, 9
43702	13	50624W	11	58615	16	80616W	5, 17	101705W	7, 9
43703	13	50672W	16	58616	16	80617W	5, 17	101706W	7, 9
43704	13	50673W	16	58643	16	81403HV	4, 18	101707W	7, 9
43705	13	50674W	16	58644	16	81404HV	4, 18	C42404	20
43706	13	50675W	16	58653	16	81405HV	4, 18	C42406	20
43707	13	50676W	16	58654	16	81406HV	4, 18	FSTR4-54	25
43710	13	50677W	16	58655	16	81406HV-RF375	4, 20	FSTR5-55	25
43712	13	50682	10, 15	58744-53	24	81407HV	4, 18	HCE4-43	25
43713	13	51403/51403HV	18	58744-54	24	81407HV-RF400	4, 20	HCE4-44	25
43714	13	51403W/51403WHV	18	58754-53	24	81407HV-RF475	4, 20	HCE4-53	25
43717	13	51404/51404HV	18	58754-54	24	81413HV	4, 19	HCE4-54	25
43720	13	51404W/51404WHV	18	58755-55	24	81414HV	4, 19	HCE4-63	25
43721	13	51405/51405HV	18	58764-54	24	81415HV	4, 19	HCE4-64	25
43722	13	51405W/51405WHV	18	58765-55	24	81416HV	4, 19	HCE4-73	25
43722-OH	13	51406/51406HV	18	58766-56	24	81416HV-RF375	4, 20	HCE4-74	25
43723	13	51406HV-RF375	20	58774-44	24	81417HV	4, 19	HCE4-94	25
43723-OH	13	51406W/51406WHV	18	58775-45	24	81417HV-RF400	4, 20	HCE5-44	25
43724	13	51407HV-RF400	20	58776-56	24	81417HV-RF475	4, 20	HCE5-45	25
43724-OH	13	51407HV-RF475	20	58854-53	24	81424HV	4, 19	HCE5-54	25
43725	13	51407WHV	18	58854-54	24	81702	4, 9	HCE5-55	25
43726	13	51413/51413HV	19	58855-55	24	81702W	4, 9	HCE5-64	25
43727	13	51413KIT/51413HVKIT	19	58864-54	24	81703	4, 9	HCE5-65	25
43814	13	51413W/51413WHV	19	58865-55	24	81703W	4, 9	HCE5-74	25
43817	13	51413WKIT/51413WHVKIT	19	62023W-18	34	81704	4, 9	HCE5-75	25
43900	13	51414/51414HV	19	62023W-18-B	34	81704W	4, 9	HCE6-56	25
43901	13	51414KIT/51414HVKIT	19	62033W-18	34	81705	4, 9	RF4-54	25
43902	13	51414W/51414WHV	19	62033W-18-B	34	81705W	4, 9	RF5-55	25
43903	13	51414WKIT/51414WHVKIT	19	62702W	9, 34	81706	4, 9	RR42404	20
43904	13	51415/51415HV	19	62702W-B	9, 34	81706W	4, 9	RR42406	20
43905	13	51415KIT/51415HVKIT	19	62703W	9, 34	81707	4, 9		
43906	13	51415W/51415WHV	19	62703W-B	9, 34	81707W	4, 9		
43907	13	51415WKIT/51415WHVKIT	19	62704W	9, 34	81708W	4, 9		
44443WCOM	31	51416/51416HV	19	62704W-B	9, 34	81709W	4, 9		
44443WPR	30	51416HV-RF375	20	73102W	15, 26	81710W	4, 9		
44443WPR2	30	51416W/51416WHV	19	73102W-CAN	15, 26	84443WPR	5, 30		
44443WPR3	31	51417HV-RF400	20	73103W	15, 26	84443WPR2	5, 30		

ONE APPIAN WAY WORCESTER, MA 01610

P.O. BOX 59 WORCESTER, MA 01613

Phone: (800) 225-9529

Fax: (800) 336-5133

email: sales@webstonevalves.com

www.webstonevalves.com

**DISTRIBUTION FACILITIES
THROUGHOUT NORTH AMERICA**

Webstone

VALVE INNOVATION

QUALITY AND COMMITMENT SINCE 1954

Founded in 1954, Webstone is one of the oldest companies of its kind in the United States. We design, manufacture and distribute domestic and imported plumbing products for residential, commercial and industrial use.



This content has been provided for the express purpose of demonstrating a product's function in a system and should not be used as a reference for designing or assembling any working installation. The user is solely responsible for ensuring that all products are used and all systems are designed in accordance with all applicable federal, state and local codes.

* All manufacturer names, models and part numbers are trademarked or registered trademark property of their respective owners.

Webstone products are not manufactured, sponsored, authorized, or endorsed by any party unless otherwise noted.

Aquatherm® is a registered trademark of aquatherm GmbH, used with permission. Visit www.aquatherm.com for additional information related to the PP-R socket ends, PP-R pipe and fittings, and socket fusion welding.

The Isolator® and Pro-Pal® are registered trademarks of Webstone

© 2016 Webstone, a brand of NIBCO

FPC-0116rev0616